

## AUTOMOTIVE CURRENT TRANSDUCER FLUXGATE TECHNOLOGY

CAB 500-C/SP1, CAB 500-C/SP2, CAB 500-C/SP5, CAB 500-C/SP5-001, CAB 500-C/SP5-012, CAB 500-C/SP7



### Introduction

The CAB family is for battery monitoring applications where high accuracy and very low offset are required. It offers galvanic separation between primary circuit (high voltage) and the secondary circuit (12 V system).

### Features

- Transducer using Fluxgate technology
- Unlimited over-current capability
- Panel mounting
- Unipolar +12 V battery power supply
- Output signal: High speed CAN (up to 500 kpbs)
- Configurable internal digital low-pass frequency filter
- Connector type: Tyco AMP 1473672-1
- Configurable CAN speed/CAN ID
- UL508 compliant
- CE marking
- Ingress Protection - IP42 level.

### Advantages

- Offset below 10 mA
- Total error 0.3 % at [ 25 °C]
- Total error 0.5 % at [-40 °C to 85 °C]
- Full galvanic separation.

### Automotive applications

- Hybrid and electric vehicle battery pack
- Conventional lead-acid batteries
- Accurate current measurement for battery management applications (SOC, SOH, SOF, etc...).

### Principle of Fluxgate Transducers

A low-frequency fluxgate transducer is made of a wound core which saturates under low induction. A current chopper switches the winding's current to saturate the magnetic core alternatively at  $\pm B$  max with a fixed frequency. Fluxgate transducers use the change of the saturation's point symmetry to measure the primary current. Due to the principle of switching the current, all offsets (electric and magnetic) are cancelled.

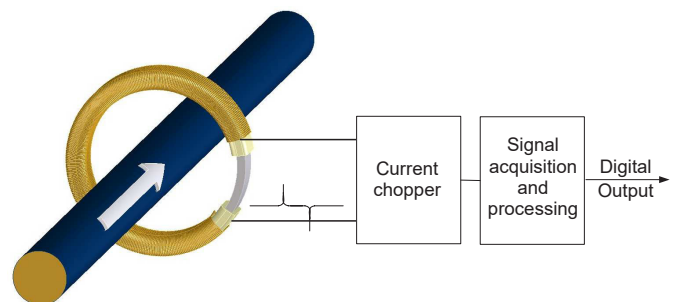

CAB 500-C series	Plastic	Mass	Hardware feature	Mounting recommendation		
				Metal insert mounting ears	Screw recommendation	Torque recommendation
CAB 500-C/SP1	PBT-GF30	68 g	-	Yes	M6	8 Nm ±20%
CAB 500-C/SP2		67 g	Choke coil on CAN interface	-	Plastic-rivet	Max load 70 N
CAB 500-C/SP5		67 g	-	-	Plastic-rivet	Max load 70 N
CAB 500-C/SP5-001		67 g	-	-	Plastic-rivet	Max load 70 N
CAB 500-C/SP5-012		67 g	Integrated 120 ohm termination resistor	-	Plastic-rivet	Max load 70 N
CAB 500-C/SP7		70 g	-	Yes	M4	2 Nm ±5%

**Laser Marking**

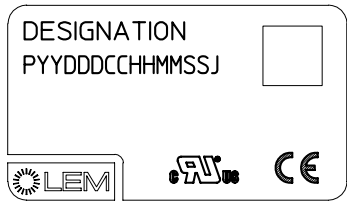
Designation	Datacode	2D matrix	2D matrix content	Text marking area
CAB 500-C/SP1	P = Production center ID YY = Last two digit of the year DDD = Day number of the year CC = Machine ID HH = Hour MM = Minute SS = Second J = Machine jig ID	NO	-	
CAB 500-C/SP2		NO	-	
CAB 500-C/SP5		YES	90.H5.50.005.0PYYDDDC HHMMSSJ	
CAB 500-C/SP5-001		YES	PYYDDDCCHHMMSSJ90. H5.50.015.0	
CAB 500-C/SP5-012		YES	90.H5.50.125.0PYYDDDC HHMMSSJ	
CAB 500-C/SP7		YES	90.H5.50.007.0PYYDDDC HHMMSSJ	



CAB 500-C/SP7

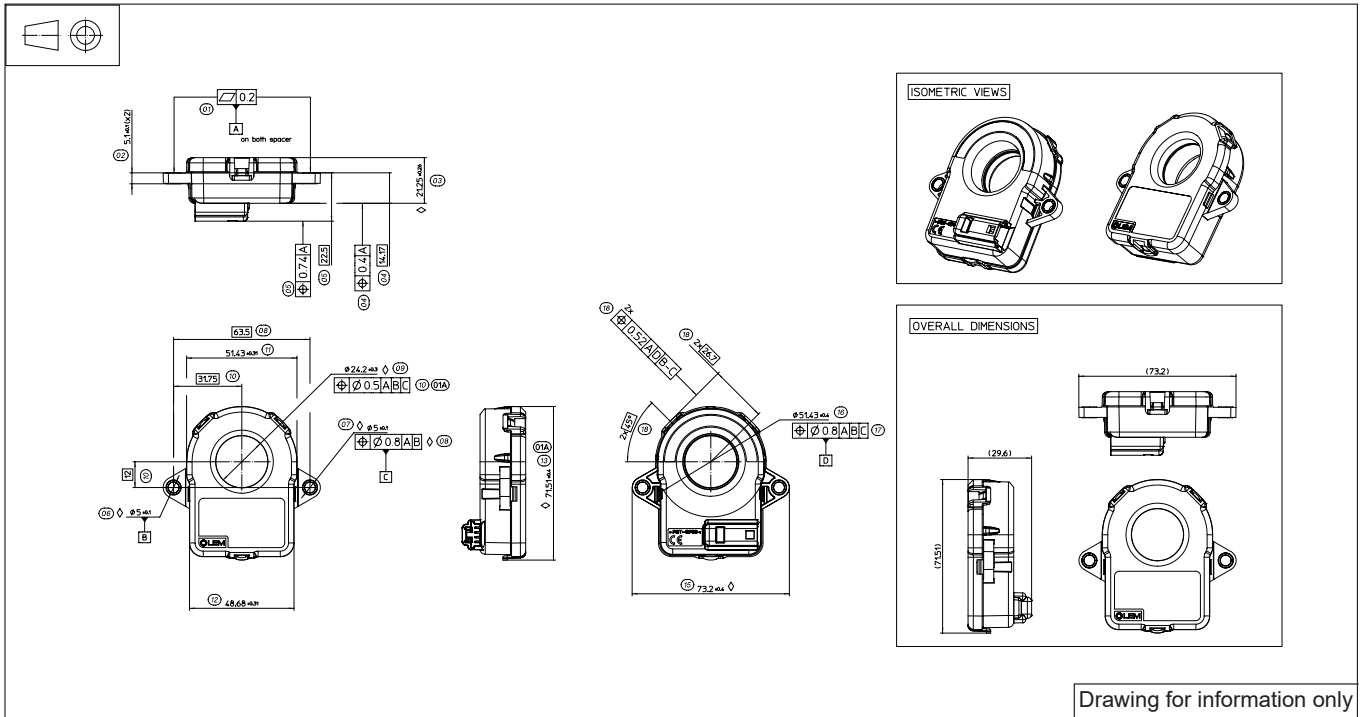

Mounting Recommendation

- Current direction

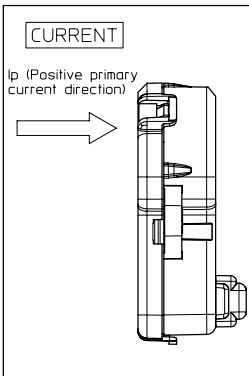

- Connector definition TE connector, mates with: 1473672-1

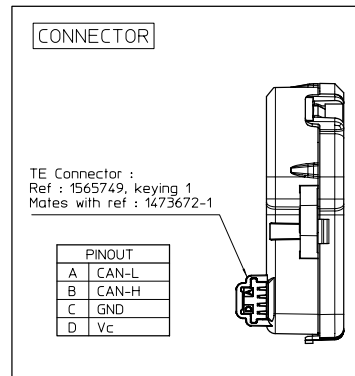

**Absolute maximum ratings (not operating)**

Parameter	Symbol	Unit	Specification	Conditions
Load dump overvoltage	$U_C$	V	32	400 ms
Over-voltage	$U_C$	V	24	1 minute
Reverse polarity	$U_C$	V	-16	1 minute
Minimum supply voltage	$U_{C\min}$	V	6	continuous, not operating
Maximum supply voltage	$U_{C\max}$	V	18	continuous, not operating
Creepage distance	$d_{Cp}$	mm	7.2	
Clearance	$d_{Cl}$	mm	6.95	
RMS voltage for AC insulation test	$U_d$	KV	2.5	50 Hz, 1 min
Insulation resistance	$R_{INS}$	MΩ	500	500 V - ISO 16750-2
IP Level			IP 42	

**Characteristics in nominal range**

Parameter	Symbol	Unit	Specification			Conditions
			Min	Typical	Max	
<b>Electrical Data</b>						
Supply voltage	$U_C$	V	8	13.5 <sup>1)</sup>	16	
Current consumption @ $I_p = 0$ A	$I_C$	mA		40	45	@ $U_C = 13.5$ V, CAN acknowledge, $T$ °C Range
Current consumption @ $I_p = 500$ A	$I_C$	mA		140	160	@ $U_C = 13.5$ V, CAN acknowledge, $T$ °C Range
Ambient operating temperature	$T_A$	°C	-40		85	Temperature range with accuracy guaranteed $\pm 3$ sigma
<b>Performance Data</b>						
Primary nominal DC or RMS current	$I_{PN}$	A	-500		500	
Current clamping value		A	-530		530	
Voltage clamping value max		V		18		When $U_C$ increases
				17.35		When $U_C$ decreases
Voltage clamping value min		V		7.75		When $U_C$ increases
				7.27		When $U_C$ decreases
Linearity error	$\varepsilon_L$	%		0.1		at room temperature
Output noise		mA		$\pm 10$		
Output frequency of CAN signal <sup>2)</sup>		Hz		100		Depends on the filter implemented
Start-up time	$t_{start}$	ms		150		
Setting time after overload		ms		20		

Notes: <sup>1)</sup> For the classical 12 V Lead-acid battery system, the mean value of battery voltage becomes to 13.5 V during charging

<sup>2)</sup> Output frequency depends on the emission period of the frame without digital filter.

## Total Error Graph for all CAB 500-C Series

Performances are considered with average value over 10 CAN frames(100 ms)

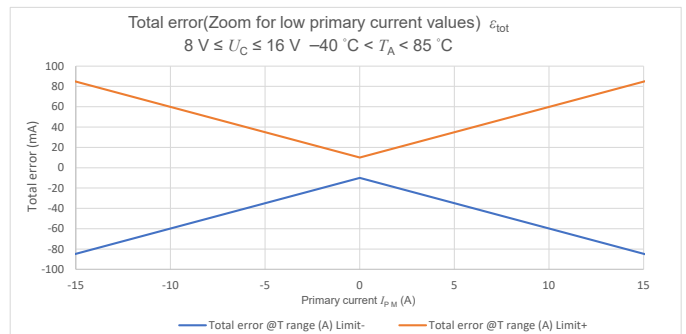
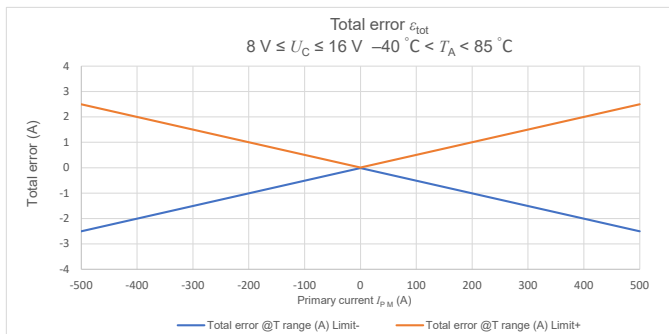
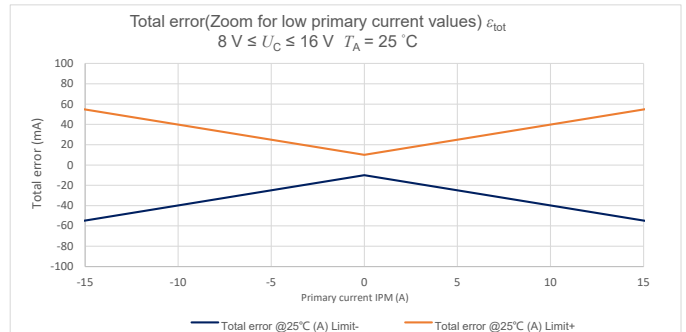
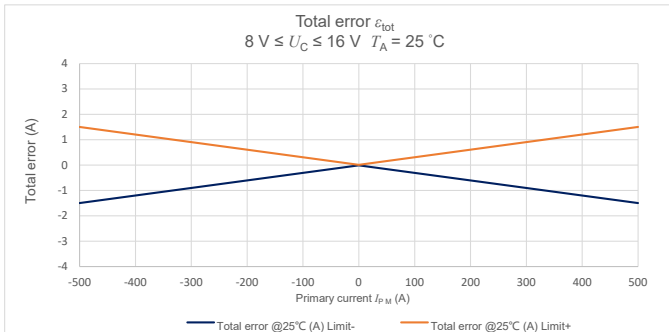

$I_p$ (A)	Total error @ 25 °C (A)	Total error @T range (A)
-500	±1.5	±2.5
0	±0.01	±0.01
500	±1.5	±2.5

## Software Version

Applicable: CAB 500-C/SP1, CAB 500-C/SP5, CAB 500-C/SP5-XXX, CAB 500-C/SP7

- CAN protocol 2.0 B
- Bit order: big endian (Motorola)
- CAN oscillator tolerance: 0.27 %
- No sleep mode capability
- 120 ohm termination resistor to be added externally (except CAB 500-C/SP5-012), internal CAN impedance = 4.8 Kohm
- CAB 500-C/SP5-012 integrates 120 ohm termination resistor inside sensor
- Refer to CAB 500 User guide for CAN modification 210208/1.

Products	CAN speed <sup>1)</sup>	CAN ID <sup>1)</sup>	Message description	Name	Data length (Nb bytes)	Type of frame	Message launch type <sup>1)</sup>
CAB 500-C/SP1	500	0x3C2	Return Current $I_p$ (mA)	CAB 500_IP	8	Standard	Cyclic message period 10±1 ms
CAB 500-C/SP5	500	0x3C2					
CAB 500-C/SP5-001	250						
CAB 500-C/SP5-012	500						
CAB 500-C/SP7	500						

Signal description	Signal name	Start bit	Length
$I_p$ Value: 80000000 H = 0 mA, 7 FFFFFFFH = -1 mA, 80000001 H = 1 mA	CSM_BAT_CURRENT	24	32
Error indication (1 bit) 0=Normal 1=Failure	ERROR_INDICATION	32	1
Error information (7 bits)	CSM_FAIL	33	7
CAB (16 bits)	PRODUCT_NAME	48	16
Software Revision (8 bit)	SW_Revision	56	8

Note: <sup>1)</sup> Parameters are configurable except CAB 500-C/SP1.

## Software Version

Applicable: CAB 500-C/SP2

- CAN protocol 2.0 B
- Bit order: big endian (Motorola)
- CAN oscillator tolerance: 0.27 %
- No sleep mode capability
- 120 ohms termination resistor to be added externally, internal CAN impedance = 4.8 kohm
- Choke coil on the CAN interface
- Refer to CAB 500 User guide for CAN modification 210208/1.

Message Description	CAN ID	Name	Data Length (Nb bytes)	Type of frame	Message launch type	Signal description	Signal name	Start bit	Length
Return Current $I_p$ (mA)	0x3C2	CAB 500_IP	8	Standard	Cyclic message period 10±1 ms	$I_p$ Value: 80000000H = 0 mA, 7FFFFFFFH = -1 mA, 80000001H = 1 mA	CSM_BAT_CURRENT	24	32
						Error indication (1 bit) 0 = Normal 1 = Failure	ERROR_INDICATION	32	1
						Error information (7 bits)	CSM_FAIL	33	7
						CAB (16 bits)	PRODUCT_NAME	48	16
						Software Revision (8 bit)	SW_Revision	56	8
Start/Stop CAN TX	0x6F0	TX_Control	8	Standard	Asynchronous received message	Set to 0x02	PCI	0	8
						0x28 (Stop CAN) / 0x29 (Start CAN)	BS	8	8
						Set to 0x02	STmin	16	8
						Set to 0xFFFF FFFF	VACANT_DATA_5 BYTES	56	40



## Error Management

Applicable: CAB 500-C/SP1, CAB 500-C/SP2, CAB 500-C/SP5, CAB 500-C/SP5-XXX, CAB 500-C/SP7

Failure Mode	$I_p$ Value	Error Indication	Error Information
Memory Error	0x FFFF FFFF	1	0x40
Overcurrent Detection $I_p >$ Approximate 580 A	0x FFFF FFFF	1	0x41
Fluxgate has no oscillation for more than 20 ms	0x FFFF FFFF	1	0x42
Clock derivation <sup>1)</sup>	0x FFFF FFFF	1	0x44
Supply voltage is out of range	0x FFFF FFFF	1	0x46
Hardware default ADC channel	0x FFFF FFFF	1	0x47
New Data not available	0x FFFF FFFF	1	0x49
Hardware default DAC Threshold	0x FFFF FFFF	1	0x4A
Hardware default Reference voltage	0x FFFF FFFF	1	0x4B

Note: <sup>1)</sup> Not available for CAB 500-C/SP1.

**Applicable Standards**

Test	Standard	Procedure
<b>Environmental test</b>		
Low Temperature Operating Endurance	ISO 16750-4 (04/2010)	120 hrs, -40 °C, power on
High Temperature Operating Endurance	ISO 16750-4 (04/2010)	85 °C, 120 hrs, power on
Powered Thermal Cycle Endurance	ISO16750-4 (04/2010)	-40 °C(20 min soak) / +85 °C(20 min soak), slope 4 °C/min, 540 cycles (936 h, 39 days), power supply 13.5 V
Thermal Shock	ISO 16750-4 (04/2010)	-40 °C(20 min soak) / +85 °C(20 min soak), 1000 cycles (667 h, 28 days); no power supply
Thermal Humidity Cycle	ISO 16750-4 (04/2010)	-10 °C /+65 °C, 93 % humidity, 10 cycles (240 hrs), no power supply
High Temperature and Humidity Endurance	JESD 22-A101 (03/2009)	85 °C, 85 % humidity, 1000 hrs
Vibration	ISO 16750-3 (12/2012)	Test IV, -40 °C / +85 °C during 8 hours (Fig.1), r.m.s. acceleration 27.1 m/s <sup>2</sup> , 20 h / axis, 3 axis+, power on and output monitoring
Mechanical Shock	ISO16750-3 (12/2012)	500 m/s <sup>2</sup> , 10 each direction (60 total), Half sine pulse
Handling Drop (Free Fall)	ISO16750-3 (12/2012)	2 falls per DUT, 3 axis, total 6 falls, from 1 meter on concrete floor
Water Intrusion	DIN 40050-9 (1993-05)	IPx2, flow 3 (+0.5/0) mm/min, 10 mins, connector downward, parts inclined at 15°
Dust (and other solid intrusion)	DIN 40050-9 (1993-05)	IP4x, The rigid stem, 1 mm diameter, is pressed against the casing of the part with a 1N force Vertical flow chamber, Portland cement, 2 kg/m <sup>3</sup> , 6 s ON/15 min OFF for 20 cycles, parts inclined at 15°
Mixed Flowing Gas	IEC60068-2-60 (12/1996)	Mehod4 in Table1, H2S, NO2, Cl2, SO2, 25±1 °C, RH 75±3 %, 21 days
Salt Fog	NISSAN M0158(2009) / M0140(2014)	NaCl 50 g/L, Cycle: salt spray 4 hrs, dry 2 hrs with 60 °C <30 % RH, moistening 2 hrs with 50 °C 95 % RH, 110 cycles
<b>EMC test</b>		
Conducted emission- Voltage method	CISPR 25 (03/2008)	9 kHz to 110 MHz, Class 3
Conducted emission- Current method	CISPR 25 (03/2008)	20 Hz to 110 MHz, Class 3
Emission Radiated (ALSE)	CISPR 25 (03/2008)	0.1 MHz to 5 GHz, Class 3
IMMUNITY TO CURRENT INJECTION (BCI)	ISO 11452-4 (12/2011)	Test level II and Test level IV AnnexE TableE.1
Immunity to Radiated field- Anechoic chamber(ALSE)	ISO 11452-2 (11/2004)	Test frequency: 80 MHz-3.2 GHz, Test level: 100 V/m 200 V/m
Low frequency magnetic field immunity	ISO 11452-8 (06/2015)	0.05 kHz to 200 kHz
RESISTANCE TO PULSES 1, 2A,2B (Transient Disturbance conducted along supply line)	ISO 7637-2 §5.6 (2004)	1: $U_s = -100$ V pulse number = 500; 2a: $U_s = +37$ V pulse number = 500; 2b: $U_s = +10$ V pulse number=10

Test	Standard	Procedure
Resistance to pulses 3a & 3b (Transient Disturbance conducted along supply line)	ISO 7637-2 §5.6 (2004)	3a: $U_s = -150$ V pulse time = 10 min; 3b: $U_s = 100$ V pulse time = 10 min
Resistance to pulses 4 (Transient Disturbance conducted along supply line)	ISO 7637-2 §5.6 (2004)	4: $U_s = -6$ V $U_a = -2.5$ Number of pulse = 1
Load Dump Resistance to 5b pulses. (Transient Disturbance conducted along supply line)	ISO 7637-2 §5.6 (2004)	5b: $U_s = 30$ V $U_s = 21.5$ V Number of pulse = 5
Transient disturbance conducted along i/o or sensor lines	ISO 7637-3 (2007)	Fast a: CCC $-150$ V 10 min; Fast b: CCC $+100$ V 10 min slow pulse positive: ICC $+20$ V 20 min; slow pulse negative: ICC $-20$ V 20 min
ESD Handling test	ISO 10605 (2008)	Un-powered, pins: $\pm 4$ kV, housing: $\pm 8$ kV, air: $\pm 15$ kV and $\pm 30$ kV
ESD Operating test	ISO 10605 (2008)	Powered, indirect contact discharge: $\pm 4$ kV $\pm 8$ kV $\pm 15$ kV $\pm 25$ kV, air: $\pm 8$ kV $\pm 20$ kV
<b>Electrical test</b>		
Direct current supply voltage	ISO 16750-2 §4.2 (11/2012)	Code B
Overvoltage	ISO 16750-2 §4.3.1 (11/2012)	18 V, 1 h, @ $65$ °C ; 24 V, 1 min, @ $25$ °C
Superimposed Alternating Voltage	ISO 16750-2 §4.4 (11/2012)	Severity2: $U_{pp} = 4$ V, Serverity4: $U_{pp} = 2$ V
Resistance to slow decrease and increase of supply voltage	ISO 16750-2 §4.5 (11/2012)	$U_{min} = 8$ V, 0.5 V/mim, Run DUT 10 min
Momentary drop in supply voltage	ISO 16750-2 §4.6.1 (11/2012)	Room temperature, $U_{s min}$ to 4.5 V
Resistance to power supply micro interruption	Renault 36-00-808 6.1.10	14 V to 0 V, 10 us (Class A), 100 us (Class B), 5 ms (Class B), 50 ms (Class C), 300 ms (Class C)
Reset behaviour at voltage drop	ISO 16750-2 §4.6.2 (11/2012)	$U_{s min} = 8$ V
Starting profile	ISO 16750-2 §4.6.3 (11/2012)	System with 12 V nominal voltage Level I
Reverse voltage	ISO 16750-2 §4.7 (11/2012)	Case 2
Ground reference and supply offset	ISO 16750-2 §4.8 (11/2012)	Offset voltage = $1.0 \pm 0.1$ V
Open Circuit	ISO 16750-2 §4.9 (11/2012)	Single line / Multiple line interruption
Short circuit protection	ISO 16750-2 §4.10.2 (11/2012)	Signal circuits, $U_{s max} = 16$ V and GND, duration 60 s

Installation influence

Overview

The CAB 500-C family uses a very accurate technology and offers the customers the current measurement needed to the application. In order to respect this accuracy, some conditions must be respected during the design of the environment of the sensor:

- Primary busbar centering
- Bus-bar shape
- Contactors position



The busbar dimension for test: 20 mm(W)x3 mm(H).  
Environment: room temperature.



Due to the complexity of practical application, the examples cannot cover all the application conditions.



It can be reference during BDU design, but the performance validation of BDU is necessary.



The sensor has different performance on different angles. For details or any further questions, please contact LEM Technical Customer Support.

Return busbar type definition

Explanation: **Recommended** / **Case of accuracy close to the limit** / **Not recommended**

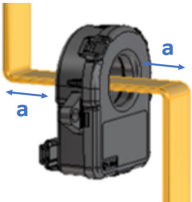
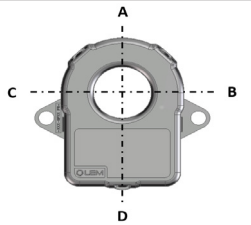
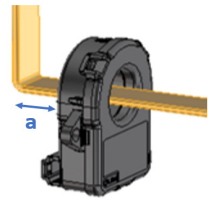
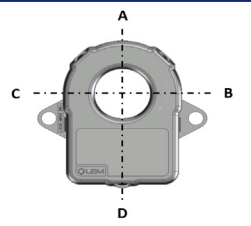
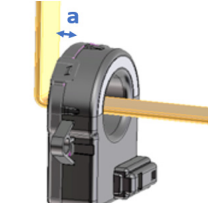
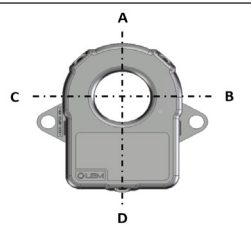
S-shape busbar recommendation																			
		<table border="1"> <tr> <th>a(mm)</th> <th>A</th> <th>B</th> <th>C</th> <th>D</th> </tr> <tr> <td>10</td> <td>A</td> <td>B</td> <td>C</td> <td>D</td> </tr> <tr> <td>&gt;10</td> <td>A</td> <td>B</td> <td>C</td> <td>D</td> </tr> </table>			a(mm)	A	B	C	D	10	A	B	C	D	>10	A	B	C	D
a(mm)	A	B	C	D															
10	A	B	C	D															
>10	A	B	C	D															
L-shape busbar recommendation																			
		<table border="1"> <tr> <th>a(mm)</th> <th>A</th> <th>B</th> <th>C</th> <th>D</th> </tr> <tr> <td>10</td> <td>A</td> <td>B</td> <td>C</td> <td>D</td> </tr> <tr> <td>&gt;10</td> <td>A</td> <td>B</td> <td>C</td> <td>D</td> </tr> </table>			a(mm)	A	B	C	D	10	A	B	C	D	>10	A	B	C	D
a(mm)	A	B	C	D															
10	A	B	C	D															
>10	A	B	C	D															
		<table border="1"> <tr> <th>a(mm)</th> <th>A</th> <th>B</th> <th>C</th> <th>D</th> </tr> <tr> <td>10</td> <td>A</td> <td>B</td> <td>C</td> <td>D</td> </tr> <tr> <td>&gt;10</td> <td>A</td> <td>B</td> <td>C</td> <td>D</td> </tr> </table>			a(mm)	A	B	C	D	10	A	B	C	D	>10	A	B	C	D
a(mm)	A	B	C	D															
10	A	B	C	D															
>10	A	B	C	D															

U1-shape busbar recommendation

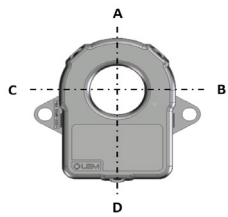
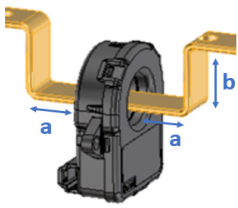

b(mm)	a(mm)					
	10		20		30	
40	A	B	A	B	A	B
	C	D	C	D	C	D
50	A	B	A	B	A	B
	C	D	C	D	C	D
60	A	B	A	B	A	B
	C	D	C	D	C	D

U2-shape busbar recommendation

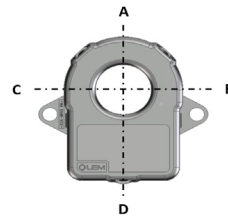
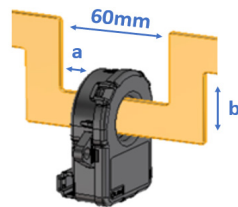

b(mm)	a(mm)					
	10		20		30	
40	A	B	A	B	A	B
	C	D	C	D	C	D
50	A	B	A	B	A	B
	C	D	C	D	C	D

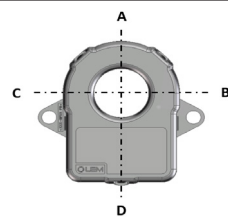
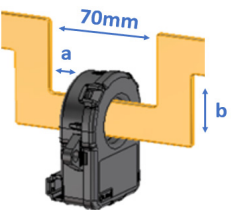

b(mm)	a(mm)							
	10		20		30		40	
50	A	B	A	B	A	B	A	B
	C	D	C	D	C	D	C	D

U3-shape busbar recommendation

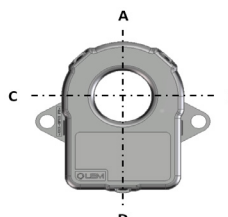
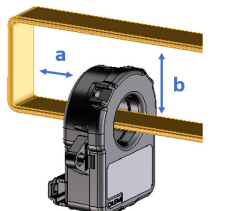

b(mm)	a(mm)											
	20		30		40		50		60			
70	A	B	A	B	A	B	A	B	A	B	A	B
	C	D	C	D	C	D	C	D	C	D	C	D
80	A	B	A	B	A	B	A	B	A	B	A	B
	C	D	C	D	C	D	C	D	C	D	C	D
90	A	B	A	B	A	B	A	B	A	B	A	B
	C	D	C	D	C	D	C	D	C	D	C	D
100	A	B	A	B	A	B	A	B	A	B	A	B
	C	D	C	D	C	D	C	D	C	D	C	D

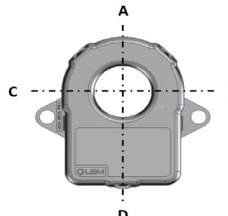
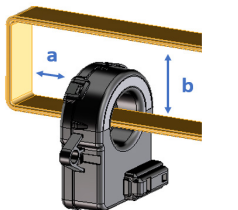

b(mm)	a(mm)											
	20		30		40		50		60			
70	A	B	A	B	A	B	A	B	A	B	A	B
	C	D	C	D	C	D	C	D	C	D	C	D
80	A	B	A	B	A	B	A	B	A	B	A	B
	C	D	C	D	C	D	C	D	C	D	C	D
90	A	B	A	B	A	B	A	B	A	B	A	B
	C	D	C	D	C	D	C	D	C	D	C	D
100	A	B	A	B	A	B	A	B	A	B	A	B
	C	D	C	D	C	D	C	D	C	D	C	D

U4-shape busbar recommendation

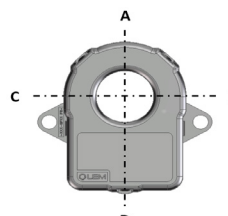
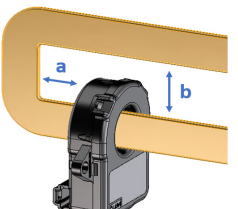

b(mm)	a(mm)							
	20		30		40		50	
70	A	B	A	B	A	B	A	B
	C	D	C	D	C	D	C	D
80	A	B	A	B	A	B	A	B
	C	D	C	D	C	D	C	D
90	A	B	A	B	A	B	A	B
	C	D	C	D	C	D	C	D
100	A	B	A	B	A	B	A	B
	C	D	C	D	C	D	C	D

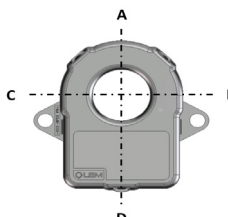
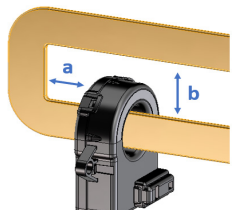

b(mm)	a(mm)							
	20		30		40		50	
70	A	B	A	B	A	B	A	B
	C	D	C	D	C	D	C	D
80	A	B	A	B	A	B	A	B
	C	D	C	D	C	D	C	D
90	A	B	A	B	A	B	A	B
	C	D	C	D	C	D	C	D
100	A	B	A	B	A	B	A	B
	C	D	C	D	C	D	C	D