

Ref: HLSR 10-SM, HLSR 16-SM, HLSR 20-SM, HLSR 32-SM, HLSR 40-SM, HLSR 50-SM

For the electronic measurement of current: DC, AC, pulsed..., with galvanic separation between the primary and the secondary circuit.

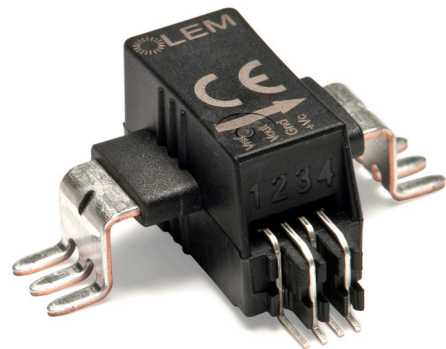

Features

- Open loop multi-range current transducer
- Voltage output
- Single supply +5 V
- Galvanic separation between primary and secondary
- Low power consumption
- Compact design for surface mount PCB mounting
- Factory calibrated
- High bandwidth, very low loss magnetic core.

Advantages

- Extremely low profile: $h = 12 \text{ mm}$
- Low foot-print
- Low offset drift
- Over-drivable U_{ref} .

Applications

- AC variable speed and servo motor drives
- Static converters for DC motor drives
- Battery supplied applications
- Uninterruptible Power Supplies (UPS)
- Switched Mode Power Supplies (SMPS)
- Power supplies for welding applications
- Combiner box
- MPPT.

Standards

- EN 50178: 1997
- IEC 61010-1: 2010
- IEC 61326-1: 2012
- UL 508: 2010.

Application Domain

- Industrial.

Absolute maximum ratings

| Parameter | Symbol | Unit | Value |
|--|----------------|------|-------|
| Supply voltage (not destructive) | U_C | V | 8 |
| Supply voltage (not entering non standard modes) | U_C | V | 6.5 |
| Primary conductor temperature | T_B | °C | 120 |
| Electrostatic discharge voltage (HBM - Human Body Model) | $U_{ESD\ HBM}$ | kV | 2 |

Stresses above these ratings may cause permanent damage.
Exposure to absolute maximum ratings for extended periods may degrade reliability.

UL 508: Ratings and assumptions of certification

File # E189713 Volume: 2 Section: 5

Standards

- CSA C22.2 NO. 14-10 INDUSTRIAL CONTROL EQUIPMENT - Edition 11 - Revision Date 2011/08/01
- UL 508 STANDARD FOR INDUSTRIAL CONTROL EQUIPMENT - Edition 17 - Revision Date 2010/04/15

Ratings

| Parameter | Symbol | Unit | Comment |
|---------------------------------|-----------|---------|-------------------------------------|
| Primary involved potential | | V AC/DC | 600 |
| Max surrounding air temperature | T_A | °C | 105 |
| Primary current | I_P | A | According to series primary current |
| Secondary supply voltage | U_C | V DC | 5 |
| Output voltage | U_{out} | V | 0 to 5 |

Conditions of acceptability

- 1 - These devices have been evaluated for overvoltage category III and for use in pollution degree 2 environment.
- 2 - A suitable enclosure shall be provided in the end-use application.
- 3 - The terminals have not been evaluated for field wiring.
- 4 - These devices are intended to be mounted on a printed wiring board of end use equipment. The suitability of the connections (including spacings) shall be determined in the end-use application.
- 5 - Primary terminals shall not be straightened since assembly of housing case depends upon bending of the terminals.
- 6 - Any surface of polymeric housing have not been evaluated as insulating barrier.
- 7 - Low voltage control circuit shall be supplied by an isolating source (such as a transformer, optical isolator, limiting impedance or electro-mechanical relay).

Marking

Only those products bearing the UR Mark should be considered to be Listed or Recognized and covered under UL's Follow-Up Service. Always look for the Mark on the product.

Insulation coordination

| Parameter | Symbol | Unit | ≤ Value | Comment |
|--|------------|------|---------|--|
| RMS voltage for AC insulation test, 50 Hz, 1 min | U_d | kV | 4.3 | |
| Impulse withstand voltage 1.2/50 μ s | U_{Ni} | kV | 8 | |
| Clearance (pri. - sec.) | d_{Cl} | mm | > 8 | Shortest distance through air |
| Creepage distance (pri. - sec.) | d_{Cp} | mm | > 8 | Shortest path along device body |
| Clearance (pri. - sec.) | - | mm | 8 | When mounted on PCB with recommended layout |
| Case material | - | - | V0 | According to UL 94 |
| Comparative tracking index | <i>CTI</i> | | 600 | |
| Application example | | V | 600 | Reinforced insulation, non uniform field according to EN 50178, IEC 61010 CAT III, PD2 |
| Application example | | V | 1000 | Basic insulation, non uniform field according to EN 50178, IEC 61010 CAT III, PD2 |
| Application example | | V | 600 | According to UL 508 |

Environmental and mechanical characteristics

| Parameter | Symbol | Unit | Min | Typ | Max | Comment |
|-------------------------------|--------|------|-----|-----|-----|---------|
| Ambient operating temperature | T_A | °C | -40 | | 105 | |
| Ambient storage temperature | T_S | °C | -40 | | 105 | |
| Mass | m | g | | | 5 | |

Electrical data HLSR 10-SM

 At $T_A = 25\text{ °C}$, $U_C = +5\text{ V}$, $R_L = 10\text{ k}\Omega$ unless otherwise noted (see Min, Max, typ, definition paragraph in page 10).

| Parameter | Symbol | Unit | Min | Typ | Max | Comment |
|--|------------------------------|--------------------------------|--------|----------------------|-------|--|
| Primary nominal RMS current | I_{PN} | A | | 10 | | |
| Primary current, measuring range | I_{PM} | A | -25 | | 25 | For $U_C > 4.6\text{ V}$ |
| Number of primary turns | N_P | - | | 1 | | |
| Resistance of primary jumper @ $T_A = 25\text{ °C}$ | R_P | m Ω | | 0.21 | | |
| Resistance of primary jumper @ $T_A = 105\text{ °C}$ | R_P | m Ω | | 0.29 | | T jumper = 120 °C |
| Supply voltage ¹⁾ | U_C | V | 4.5 | 5 | 5.5 | |
| Current consumption | I_C | mA | | 19 | 25 | |
| Reference voltage (output) | U_{ref} | V | 2.48 | 2.5 | 2.52 | Internal reference |
| Reference voltage (input) | U_{ref} | V | 0.5 | | 2.65 | External reference |
| Output voltage range @ I_{PM} | $U_{out} - U_{ref}$ | V | -2 | | 2 | Over operating temperature range |
| Internal series resistance of reference voltage | R_{ref} | Ω | 130 | 200 | 300 | series |
| Output internal resistance | R_{out} | Ω | | 2 | 5 | series |
| Load capacitance | C_L | nF | 0 | | 6 | |
| Electrical offset voltage referred to primary @ $I_P = 0$ | U_{OE} | mV | -5 | | 5 | $U_{out} - U_{ref}$ @ $U_{ref} = 2.5\text{ V}$ |
| Electrical offset current referred to primary | I_{OE} | mA | -62.5 | | 62.5 | |
| Temperature coefficient of U_{ref} | TCU_{ref} | ppm/K | -170 | | 170 | -40 °C ... 105 °C |
| Temperature coefficient of U_{OE} referred to primary | TCU_{OE} | mV/K | -0.075 | | 0.075 | -40 °C ... 105 °C |
| Temperature coefficient of I_{OE} referred to primary | TCI_{OE} | mA/K | -0.94 | | 0.94 | -40 °C ... 105 °C |
| Nominal sensitivity | S_N | mV/A | | 80 | | 800 mV @ I_{PN} |
| Sensitivity error | ϵ_S | % | -0.5 | | 0.5 | Factory adjustment |
| Temperature coefficient of S | TCS | ppm/K | -200 | | 200 | -40 °C ... 105 °C |
| Linearity error 0 ... I_{PN} | ϵ_L | % of I_{PN} | -0.5 | | 0.5 | |
| Linearity error 0 ... I_{PM} | ϵ_L | % of I_{PM} | -0.5 | | 0.5 | |
| Magnetic offset current (@ $10 \times I_{PN}$) referred to primary | I_{OM} | A | -0.25 | | 0.25 | |
| Delay time @ 10 % of I_{PN} | t_{D10} | μs | | | 2 | @ 50 A/ μs |
| Delay time @ 90 % of I_{PN} | t_{D90} | μs | | | 2.5 | @ 50 A/ μs |
| Frequency bandwidth (-3 dB) | BW | kHz | | 400 | | |
| RMS noise voltage spectral density referred to primary 100 Hz ... 100 kHz | u_{no} | $\mu\text{V}/\sqrt{\text{Hz}}$ | | | 28 | |
| RMS noise voltage referred to primary DC ... 10 kHz DC ... 100 kHz DC ... 1 MHz | U_{no} | mVpp | | 17.5 46.1 65.7 | | |
| Sum of sensitivity and linearity @ I_{PN} | ϵ_{SL} | % of I_{PN} | -1 | | 1 | |
| Sum of sensitivity and linearity @ I_{PN} @ $T_A = +85\text{ °C}$ | $\epsilon_{SL85\text{ °C}}$ | % of I_{PN} | -2.9 | | 2.9 | See formula note ²⁾ |
| Sum of sensitivity and linearity @ I_{PN} @ $T_A = +105\text{ °C}$ | $\epsilon_{SL105\text{ °C}}$ | % of I_{PN} | -3.4 | | 3.4 | See formula note ²⁾ |

 Notes: ¹⁾ 3.3 V SP version available

$$^2) \epsilon_{SL}(T_A) = \epsilon_{SL25} + \left(TCS + \frac{TCI_{OE}}{I_{PN}} \right) \times |T_A - 25|$$

Electrical data HLSR 16-SM

 At $T_A = 25\text{ °C}$, $U_C = +5\text{ V}$, $R_L = 10\text{ k}\Omega$ unless otherwise noted (see Min, Max, typ, definition paragraph in page 10).

| Parameter | Symbol | Unit | Min | Typ | Max | Comment |
|--|------------------------------|--------------------------------|--------|----------------------|-------|--|
| Primary nominal RMS current | I_{PN} | A | | 16 | | |
| Primary current, measuring range | I_{PM} | A | -40 | | 40 | For $U_C > 4.6\text{ V}$ |
| Number of primary turns | N_P | - | | 1 | | |
| Resistance of primary jumper @ $T_A = 25\text{ °C}$ | R_P | m Ω | | 0.21 | | |
| Resistance of primary jumper @ $T_A = 105\text{ °C}$ | R_P | m Ω | | 0.29 | | T jumper = 120 °C |
| Supply voltage ¹⁾ | U_C | V | 4.5 | 5 | 5.5 | |
| Current consumption | I_C | mA | | 19 | 25 | |
| Reference voltage (output) | U_{ref} | V | 2.48 | 2.5 | 2.52 | Internal reference |
| Reference voltage (input) | U_{ref} | V | 0.5 | | 2.65 | External reference |
| Output voltage range @ I_{PM} | $U_{out} - U_{ref}$ | V | -2 | | 2 | Over operating temperature range |
| Internal series resistance of reference voltage | R_{ref} | Ω | 130 | 200 | 300 | series |
| Output internal resistance | R_{out} | Ω | | 2 | 5 | series |
| Load capacitance | C_L | nF | 0 | | 6 | |
| Electrical offset voltage referred to primary @ $I_P = 0$ | U_{OE} | mV | -5 | | 5 | $U_{out} - U_{ref}$ @ $U_{ref} = 2.5\text{ V}$ |
| Electrical offset current referred to primary | I_{OE} | mA | -100 | | 100 | |
| Temperature coefficient of U_{ref} | TCU_{ref} | ppm/K | -170 | | 170 | $-40\text{ °C} \dots 105\text{ °C}$ |
| Temperature coefficient of U_{OE} referred to primary | TCU_{OE} | mV/K | -0.075 | | 0.075 | $-40\text{ °C} \dots 105\text{ °C}$ |
| Temperature coefficient of I_{OE} referred to primary | TCl_{OE} | mA/K | -1.5 | | 1.5 | $-40\text{ °C} \dots 105\text{ °C}$ |
| Nominal sensitivity | S_N | mV/A | | 50 | | 800 mV @ I_{PN} |
| Sensitivity error | ϵ_s | % | -0.5 | | 0.5 | Factory adjustment |
| Temperature coefficient of S | TCS | ppm/K | -200 | | 200 | $-40\text{ °C} \dots 105\text{ °C}$ |
| Linearity error 0 ... I_{PN} | ϵ_L | % of I_{PN} | -0.5 | | 0.5 | |
| Linearity error 0 ... I_{PM} | ϵ_L | % of I_{PM} | -0.5 | | 0.5 | |
| Magnetic offset current (@ $10 \times I_{PN}$) referred to primary | I_{OM} | A | -0.25 | | 0.25 | |
| Delay time @ 10 % of I_{PN} | t_{D10} | μs | | | 2 | @ 50 A/ μs |
| Delay time @ 90 % of I_{PN} | t_{D90} | μs | | | 2.5 | @ 50 A/ μs |
| Frequency bandwidth (-3 dB) | BW | kHz | | 400 | | |
| RMS noise voltage spectral density referred to primary 100 Hz ... 100 kHz | u_{no} | $\mu\text{V}/\sqrt{\text{Hz}}$ | | | 28 | |
| RMS noise voltage referred to primary DC ... 10 kHz DC ... 100 kHz DC ... 1 MHz | U_{no} | mVpp | | 11.3 28.6 41.2 | | |
| Sum of sensitivity and linearity @ I_{PN} | ϵ_{SL} | % of I_{PN} | -1 | | 1 | |
| Sum of sensitivity and linearity @ I_{PN} @ $T_A = +85\text{ °C}$ | $\epsilon_{SL85\text{ °C}}$ | % of I_{PN} | -2.9 | | 2.9 | See formula note ²⁾ |
| Sum of sensitivity and linearity @ I_{PN} @ $T_A = +105\text{ °C}$ | $\epsilon_{SL105\text{ °C}}$ | % of I_{PN} | -3.4 | | 3.4 | See formula note ²⁾ |

 Notes: ¹⁾ 3.3 V SP version available

$$^2) \epsilon_{SL}(T_A) = \epsilon_{SL25} + \left(TCS + \frac{TCl_{OE}}{I_{PN}} \right) \times |T_A - 25|$$

Electrical data HLSR 20-SM

 At $T_A = 25\text{ °C}$, $U_C = +5\text{ V}$, $R_L = 10\text{ k}\Omega$ unless otherwise noted (see Min, Max, typ, definition paragraph in page 10).

| Parameter | Symbol | Unit | Min | Typ | Max | Comment |
|--|------------------------------|--------------------------------|--------|-------------------|-------|--|
| Primary nominal RMS current | I_{PN} | A | | 20 | | |
| Primary current, measuring range | I_{PM} | A | -50 | | 50 | For $U_C > 4.6\text{ V}$ |
| Number of primary turns | N_P | - | | 1 | | |
| Resistance of primary jumper @ $T_A = 25\text{ °C}$ | R_P | m Ω | | 0.21 | | |
| Resistance of primary jumper @ $T_A = 105\text{ °C}$ | R_P | m Ω | | 0.29 | | T jumper = 120 °C |
| Supply voltage ¹⁾ | U_C | V | 4.5 | 5 | 5.5 | |
| Current consumption | I_C | mA | | 19 | 25 | |
| Reference voltage (output) | U_{ref} | V | 2.48 | 2.5 | 2.52 | Internal reference |
| Reference voltage (input) | U_{ref} | V | 0.5 | | 2.65 | External reference |
| Output voltage range @ I_{PM} | $U_{out} - U_{ref}$ | V | -2 | | 2 | Over operating temperature range |
| Internal series resistance of reference voltage | R_{ref} | Ω | 130 | 200 | 300 | series |
| Output internal resistance | R_{out} | Ω | | 2 | 5 | series |
| Load capacitance | C_L | nF | 0 | | 6 | |
| Electrical offset voltage referred to primary @ $I_P = 0$ | U_{OE} | mV | -5 | | 5 | $U_{out} - U_{ref}$ @ $U_{ref} = 2.5\text{ V}$ |
| Electrical offset current referred to primary | I_{OE} | mA | -125 | | 125 | |
| Temperature coefficient of U_{ref} | TCU_{ref} | ppm/K | -170 | | 170 | -40 °C ... 105 °C |
| Temperature coefficient of U_{OE} referred to primary | TCU_{OE} | mV/K | -0.075 | | 0.075 | -40 °C ... 105 °C |
| Temperature coefficient of I_{OE} referred to primary | TCI_{OE} | mA/K | -1.88 | | 1.88 | -40 °C ... 105 °C |
| Nominal sensitivity | S_N | mV/A | | 40 | | 800 mV @ I_{PN} |
| Sensitivity error | ϵ_S | % | -0.5 | | 0.5 | Factory adjustment |
| Temperature coefficient of S | TCS | ppm/K | -200 | | 200 | -40 °C ... 105 °C |
| Linearity error 0 ... I_{PN} | ϵ_L | % of I_{PN} | -0.5 | | 0.5 | |
| Linearity error 0 ... I_{PM} | ϵ_L | % of I_{PM} | -0.5 | | 0.5 | |
| Magnetic offset current (@ $10 \times I_{PN}$) referred to primary | I_{OM} | A | -0.25 | | 0.25 | |
| Delay time @ 10 % of I_{PN} | t_{D10} | μs | | | 2 | @ 50 A/ μs |
| Delay time @ 90 % of I_{PN} | t_{D90} | μs | | | 2.5 | @ 50 A/ μs |
| Frequency bandwidth (-3 dB) | BW | kHz | | 400 | | |
| RMS noise voltage spectral density referred to primary 100 Hz ... 100 kHz | u_{no} | $\mu\text{V}/\sqrt{\text{Hz}}$ | | | 28 | |
| RMS noise voltage referred to primary DC ... 10 kHz DC ... 100 kHz DC ... 1 MHz | U_{no} | mVpp | | 9.2 22.8 33 | | |
| Sum of sensitivity and linearity @ I_{PN} | ϵ_{SL} | % of I_{PN} | -1 | | 1 | |
| Sum of sensitivity and linearity @ I_{PN} @ $T_A = +85\text{ °C}$ | $\epsilon_{SL85\text{ °C}}$ | % of I_{PN} | -2.9 | | 2.9 | See formula note ²⁾ |
| Sum of sensitivity and linearity @ I_{PN} @ $T_A = +105\text{ °C}$ | $\epsilon_{SL105\text{ °C}}$ | % of I_{PN} | -3.4 | | 3.4 | See formula note ²⁾ |

 Notes: ¹⁾ 3.3 V SP version available

$$^2) \epsilon_{SL}(T_A) = \epsilon_{SL25} + \left(TCS + \frac{TCI_{OE}}{I_{PN}} \right) \times |T_A - 25|$$

Electrical data HLSR 32-SM

 At $T_A = 25\text{ °C}$, $U_C = +5\text{ V}$, $R_L = 10\text{ k}\Omega$ unless otherwise noted (see Min, Max, typ, definition paragraph in page 10).

| Parameter | Symbol | Unit | Min | Typ | Max | Comment |
|--|------------------------------|--------------------------------|--------|-------------------|-------|--|
| Primary nominal RMS current | I_{PN} | A | | 32 | | |
| Primary current, measuring range | I_{PM} | A | -80 | | 80 | For $U_C > 4.6\text{ V}$ |
| Number of primary turns | N_P | - | | 1 | | |
| Resistance of primary jumper @ $T_A = 25\text{ °C}$ | R_P | m Ω | | 0.21 | | |
| Resistance of primary jumper @ $T_A = 105\text{ °C}$ | R_P | m Ω | | 0.29 | | T jumper = 120 °C |
| Supply voltage ¹⁾ | U_C | V | 4.5 | 5 | 5.5 | |
| Current consumption | I_C | mA | | 19 | 25 | |
| Reference voltage (output) | U_{ref} | V | 2.48 | 2.5 | 2.52 | Internal reference |
| Reference voltage (input) | U_{ref} | V | 0.5 | | 2.65 | External reference |
| Output voltage range @ I_{PM} | $U_{out} - U_{ref}$ | V | -2 | | 2 | Over operating temperature range |
| Internal series resistance of reference voltage | R_{ref} | Ω | 130 | 200 | 300 | series |
| Output internal resistance | R_{out} | Ω | | 2 | 5 | series |
| Load capacitance | C_L | nF | 0 | | 6 | |
| Electrical offset voltage referred to primary @ $I_P = 0$ | U_{OE} | mV | -5 | | 5 | $U_{out} - U_{ref}$ @ $U_{ref} = 2.5\text{ V}$ |
| Electrical offset current referred to primary | I_{OE} | mA | -200 | | 200 | |
| Temperature coefficient of U_{ref} | TCU_{ref} | ppm/K | -170 | | 170 | -40 °C ... 105 °C |
| Temperature coefficient of U_{OE} referred to primary | TCU_{OE} | mV/K | -0.075 | | 0.075 | -40 °C ... 105 °C |
| Temperature coefficient of I_{OE} referred to primary | TCI_{OE} | mA/K | -3 | | 3 | -40 °C ... 105 °C |
| Nominal sensitivity | S_N | mV/A | | 25 | | 800 mV @ I_{PN} |
| Sensitivity error | ϵ_S | % | -0.5 | | 0.5 | Factory adjustment |
| Temperature coefficient of S | TCS | ppm/K | -200 | | 200 | -40 °C ... 105 °C |
| Linearity error 0 ... I_{PN} | ϵ_L | % of I_{PN} | -0.5 | | 0.5 | |
| Linearity error 0 ... I_{PM} | ϵ_L | % of I_{PM} | -0.5 | | 0.5 | |
| Magnetic offset current (@ $10 \times I_{PN}$) referred to primary | I_{OM} | A | -0.25 | | 0.25 | |
| Delay time @ 10 % of I_{PN} | t_{D10} | μs | | | 2 | @ 50 A/ μs |
| Delay time @ 90 % of I_{PN} | t_{D90} | μs | | | 2.5 | @ 50 A/ μs |
| Frequency bandwidth (-3 dB) | BW | kHz | | 400 | | |
| RMS noise voltage spectral density referred to primary 100 Hz ... 100 kHz | u_{no} | $\mu\text{V}/\sqrt{\text{Hz}}$ | | | 8.75 | |
| RMS noise voltage referred to primary DC ... 10 kHz DC ... 100 kHz DC ... 1 MHz | U_{no} | mVpp | | 6.2 14 20.7 | | |
| Sum of sensitivity and linearity @ I_{PN} | ϵ_{SL} | % of I_{PN} | -1 | | 1 | |
| Sum of sensitivity and linearity @ I_{PN} @ $T_A = +85\text{ °C}$ | $\epsilon_{SL85\text{ °C}}$ | % of I_{PN} | -2.9 | | 2.9 | See formula note ²⁾ |
| Sum of sensitivity and linearity @ I_{PN} @ $T_A = +105\text{ °C}$ | $\epsilon_{SL105\text{ °C}}$ | % of I_{PN} | -3.4 | | 3.4 | See formula note ²⁾ |

 Notes: ¹⁾ 3.3 V SP version available

$$^2) \epsilon_{SL}(T_A) = \epsilon_{SL25} + \left(TCS + \frac{TCI_{OE}}{I_{PN}} \right) \times |T_A - 25|$$

Electrical data HLSR 40-SM

 At $T_A = 25\text{ °C}$, $U_C = +5\text{ V}$, $R_L = 10\text{ k}\Omega$ unless otherwise noted (see Min, Max, typ, definition paragraph in page 10).

| Parameter | Symbol | Unit | Min | Typ | Max | Comment |
|--|------------------------------|--------------------------------|--------|---------------------|-------|--|
| Primary nominal RMS current | I_{PN} | A | | 40 | | |
| Primary current, measuring range | I_{PM} | A | -100 | | 100 | For $U_C > 4.6\text{ V}$ |
| Number of primary turns | N_P | - | | 1 | | |
| Resistance of primary jumper @ $T_A = 25\text{ °C}$ | R_P | m Ω | | 0.21 | | |
| Resistance of primary jumper @ $T_A = 105\text{ °C}$ | R_P | m Ω | | 0.29 | | T jumper = 120 °C |
| Supply voltage ¹⁾ | U_C | V | 4.5 | 5 | 5.5 | |
| Current consumption | I_C | mA | | 19 | 25 | |
| Reference voltage (output) | U_{ref} | V | 2.48 | 2.5 | 2.52 | Internal reference |
| Reference voltage (input) | U_{ref} | V | 0.5 | | 2.65 | External reference |
| Output voltage range @ I_{PM} | $U_{out} - U_{ref}$ | V | -2 | | 2 | Over operating temperature range |
| Internal series resistance of reference voltage | R_{ref} | Ω | 130 | 200 | 300 | series |
| Output internal resistance | R_{out} | Ω | | 2 | 5 | series |
| Load capacitance | C_L | nF | 0 | | 6 | |
| Electrical offset voltage referred to primary @ $I_P = 0$ | U_{OE} | mV | -5 | | 5 | $U_{out} - U_{ref}$ @ $U_{ref} = 2.5\text{ V}$ |
| Electrical offset current referred to primary | I_{OE} | mA | -250 | | 250 | |
| Temperature coefficient of U_{ref} | TCU_{ref} | ppm/K | -170 | | 170 | -40 °C ... 105 °C |
| Temperature coefficient of U_{OE} referred to primary | TCU_{OE} | mV/K | -0.075 | | 0.075 | -40 °C ... 105 °C |
| Temperature coefficient of I_{OE} referred to primary | TCI_{OE} | mA/K | -3.75 | | 3.75 | -40 °C ... 105 °C |
| Nominal sensitivity | S_N | mV/A | | 20 | | 800 mV @ I_{PN} |
| Sensitivity error | ϵ_S | % | -0.5 | | 0.5 | Factory adjustment |
| Temperature coefficient of S | TCS | ppm/K | -200 | | 200 | -40 °C ... 105 °C |
| Linearity error 0 ... I_{PN} | ϵ_L | % of I_{PN} | -0.5 | | 0.5 | |
| Linearity error 0 ... I_{PM} | ϵ_L | % of I_{PM} | -0.5 | | 0.5 | |
| Magnetic offset current (@ $10 \times I_{PN}$) referred to primary | I_{OM} | A | -0.25 | | 0.25 | |
| Delay time @ 10 % of I_{PN} | t_{D10} | μs | | | 2 | @ 50 A/ μs |
| Delay time @ 90 % of I_{PN} | t_{D90} | μs | | | 2.5 | @ 50 A/ μs |
| Frequency bandwidth (-3 dB) | BW | kHz | | 400 | | |
| RMS noise voltage spectral density referred to primary 100 Hz ... 100 kHz | u_{no} | $\mu\text{V}/\sqrt{\text{Hz}}$ | | | 7 | |
| RMS noise voltage referred to primary DC ... 10 kHz DC ... 100 kHz DC ... 1 MHz | U_{no} | mVpp | | 5.1 11.1 16.6 | | |
| Sum of sensitivity and linearity @ I_{PN} | ϵ_{SL} | % of I_{PN} | -1 | | 1 | |
| Sum of sensitivity and linearity @ I_{PN} @ $T_A = +85\text{ °C}$ | $\epsilon_{SL85\text{ °C}}$ | % of I_{PN} | -2.9 | | 2.9 | See formula note ²⁾ |
| Sum of sensitivity and linearity @ I_{PN} @ $T_A = +105\text{ °C}$ | $\epsilon_{SL105\text{ °C}}$ | % of I_{PN} | -3.4 | | 3.4 | See formula note ²⁾ |

 Notes: ¹⁾ 3.3 V SP version available

$$^2) \epsilon_{SL}(T_A) = \epsilon_{SL25} + \left(TCS + \frac{TCI_{OE}}{I_{PN}} \right) \times |T_A - 25|$$

Electrical data HLSR 50-SM

 At $T_A = 25\text{ °C}$, $U_C = +5\text{ V}$, $R_L = 10\text{ k}\Omega$ unless otherwise noted (see Min, Max, typ, definition paragraph in page 10).

| Parameter | Symbol | Unit | Min | Typ | Max | Comment |
|--|------------------------------|--------------------------------|--------|--------------------|-------|--|
| Primary nominal RMS current | I_{PN} | A | | 50 | | |
| Primary current, measuring range | I_{PM} | A | -125 | | 125 | For $U_C > 4.6\text{ V}$ |
| Number of primary turns | N_P | - | | 1 | | |
| Resistance of primary jumper @ $T_A = 25\text{ °C}$ | R_P | m Ω | | 0.21 | | |
| Resistance of primary jumper @ $T_A = 105\text{ °C}$ | R_P | m Ω | | 0.29 | | T jumper = 120 °C |
| Supply voltage ¹⁾ | U_C | V | 4.5 | 5 | 5.5 | |
| Current consumption | I_C | mA | | 19 | 25 | |
| Reference voltage (output) | U_{ref} | V | 2.48 | 2.5 | 2.52 | Internal reference |
| Reference voltage (input) | U_{ref} | V | 0.5 | | 2.65 | External reference |
| Output voltage range @ I_{PM} | $U_{out} - U_{ref}$ | V | -2 | | 2 | Over operating temperature range |
| Internal series resistance of reference voltage | R_{ref} | Ω | 130 | 200 | 300 | series |
| Output internal resistance | R_{out} | Ω | | 2 | 5 | series |
| Load capacitance | C_L | nF | 0 | | 6 | |
| Electrical offset voltage referred to primary @ $I_P = 0$ | U_{OE} | mV | -5 | | 5 | $U_{out} - U_{ref}$ @ $U_{ref} = 2.5\text{ V}$ |
| Electrical offset current referred to primary | I_{OE} | mA | -313 | | 313 | |
| Temperature coefficient of U_{ref} | TCU_{ref} | ppm/K | -170 | | 170 | $-40\text{ °C} \dots 105\text{ °C}$ |
| Temperature coefficient of U_{OE} referred to primary | TCU_{OE} | mV/K | -0.05 | | 0.05 | $-40\text{ °C} \dots 105\text{ °C}$ |
| Temperature coefficient of I_{OE} referred to primary | TCl_{OE} | mA/K | -3.125 | | 3.125 | $-40\text{ °C} \dots 105\text{ °C}$ |
| Nominal sensitivity | S_N | mV/A | | 16 | | 800 mV @ I_{PN} |
| Sensitivity error | ϵ_S | % | -0.5 | | 0.5 | Factory adjustment |
| Temperature coefficient of S | TCS | ppm/K | -200 | | 200 | $-40\text{ °C} \dots 105\text{ °C}$ |
| Linearity error 0 ... I_{PN} | ϵ_L | % of I_{PN} | -0.5 | | 0.5 | |
| Linearity error 0 ... I_{PM} | ϵ_L | % of I_{PM} | -0.5 | | 0.5 | |
| Magnetic offset current (@ $10 \times I_{PN}$) referred to primary | I_{OM} | A | -0.25 | | 0.25 | |
| Delay time @ 10 % of I_{PN} | t_{D10} | μs | | | 2 | @ 50 A/ μs |
| Delay time @ 90 % of I_{PN} | t_{D90} | μs | | | 2.5 | @ 50 A/ μs |
| Frequency bandwidth (-3 dB) | BW | kHz | | 400 | | |
| RMS noise voltage spectral density referred to primary 100 Hz ... 100 kHz | u_{no} | $\mu\text{V}/\sqrt{\text{Hz}}$ | | | 5.6 | |
| RMS noise voltage referred to primary DC ... 10 kHz DC ... 100 kHz DC ... 1 MHz | U_{no} | mVpp | | 4.3 8.8 13.3 | | |
| Sum of sensitivity and linearity @ I_{PN} | ϵ_{SL} | % of I_{PN} | -1 | | 1 | |
| Sum of sensitivity and linearity @ I_{PN} @ $T_A = +85\text{ °C}$ | $\epsilon_{SL85\text{ °C}}$ | % of I_{PN} | -2.7 | | 2.7 | See formula note ²⁾ |
| Sum of sensitivity and linearity @ I_{PN} @ $T_A = +105\text{ °C}$ | $\epsilon_{SL105\text{ °C}}$ | % of I_{PN} | -3.1 | | 3.1 | See formula note ²⁾ |

 Notes: ¹⁾ 3.3 V SP version available

$$^2) \epsilon_{SL}(T_A) = \epsilon_{SL25} + \left(TCS + \frac{TCl_{OE}}{I_{PN}} \right) \times |T_A - 25|$$

Maximum continuous DC current

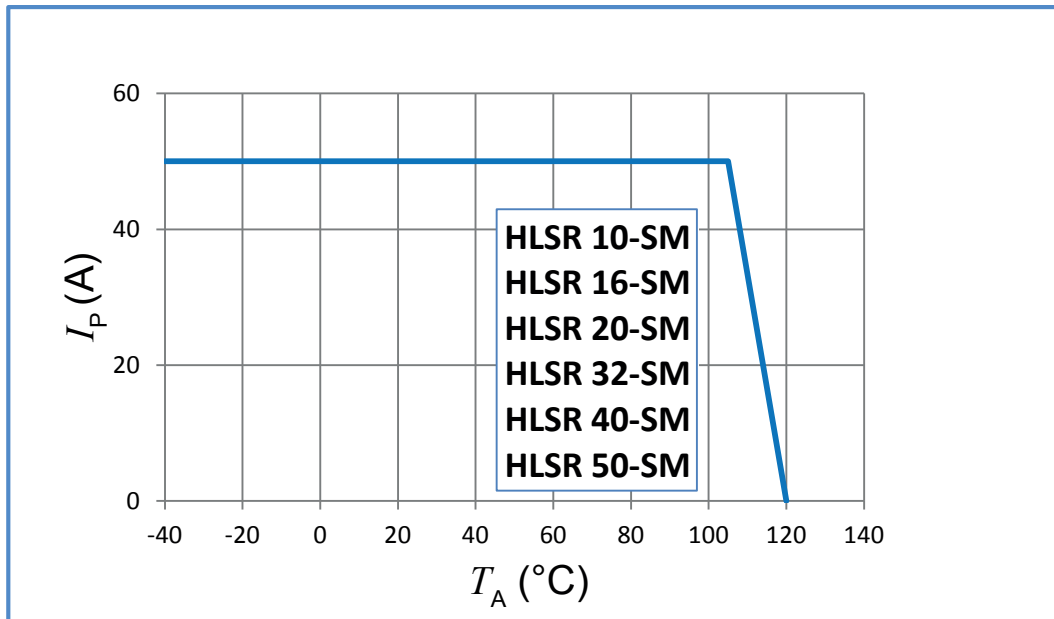

Important notice: whatever the usage and/or application, the transducer jumper temperature shall not go above the maximum ratings of 120 °C as stated in page 2 of this datasheet.

Definition of typical, minimum and maximum values

Minimum and maximum values for specified limiting and safety conditions have to be understood as such as well as values shown in “typical” graphs.

On the other hand, measured values are part of a statistical distribution that can be specified by an interval with upper and lower limits and a probability for measured values to lie within this interval.

Unless otherwise stated (e.g. “100 % tested”), the LEM definition for such intervals designated with “min” and “max” is that the probability for values of samples to lie in this interval is 99.73 %.

For a normal (Gaussian) distribution, this corresponds to an interval between -3 sigma and +3 sigma. If “typical” values are not obviously mean or average values, those values are defined to delimit intervals with a probability of 68.27 %, corresponding to an interval between -sigma and +sigma for a normal distribution.

Typical, minimum and maximum values are determined during the initial characterization of the product.

Measuring range versus external reference voltage

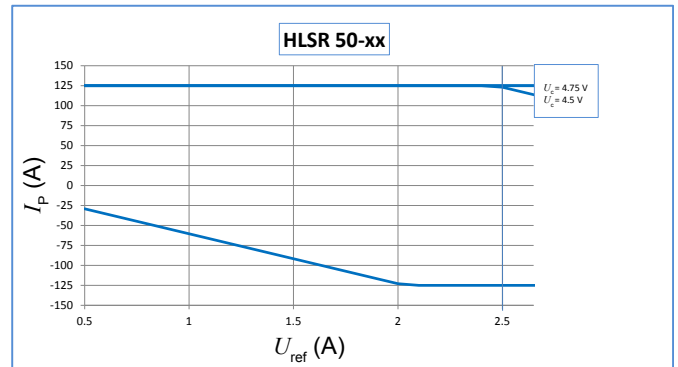
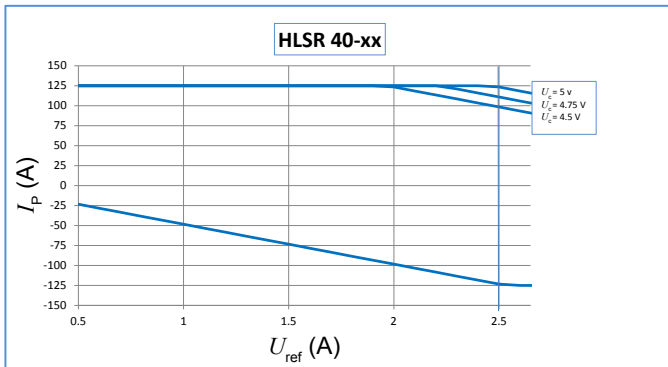
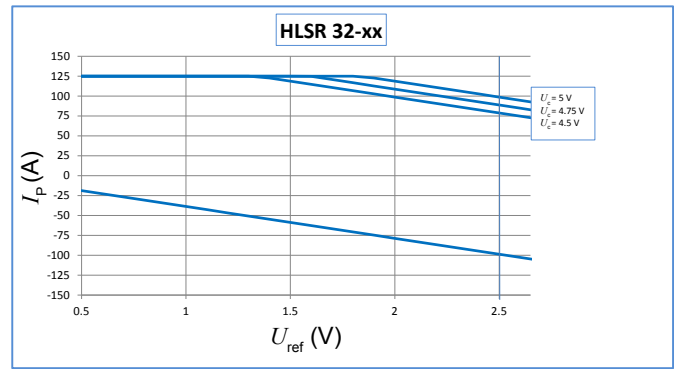
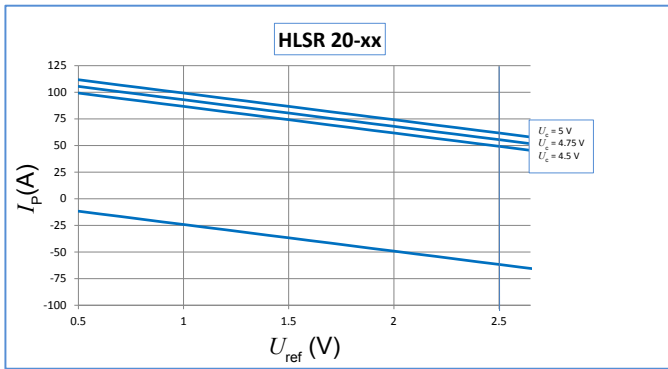
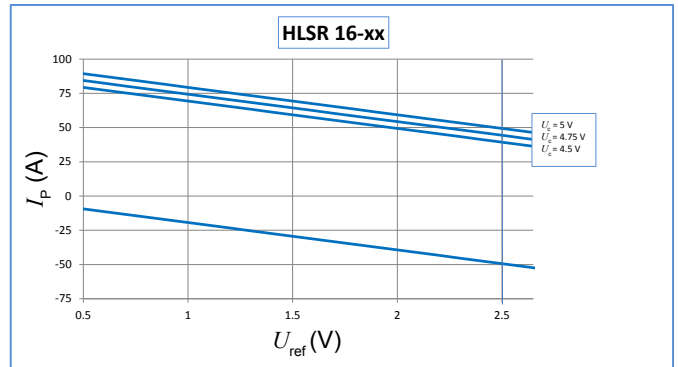
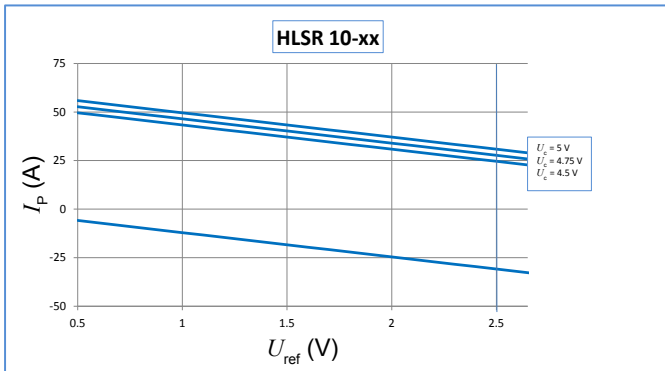

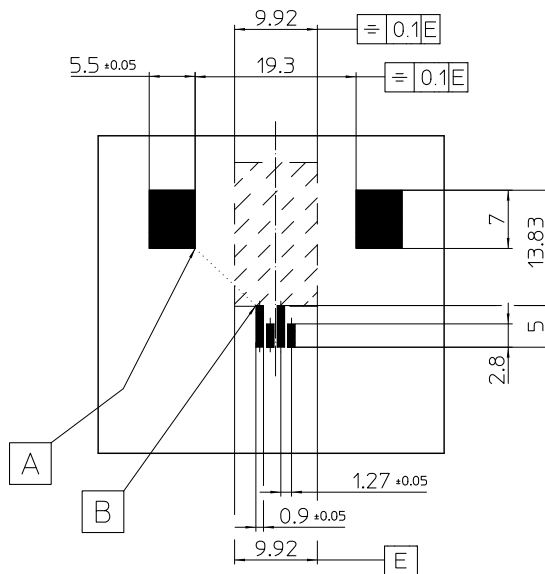
PCB footprint (in mm)

| | d_{Cl} (mm) | d_{Cp} (mm) |
|-----|---------------|---------------|
| A-B | 10 | 10 |

Assembly on PCB

- Pb free reflow profile
- No clean process only

Safety

This transducer must be used in limited-energy secondary circuits according to IEC 61010-1.



This transducer must be used in electric/electronic equipment with respect to applicable standards and safety requirements in accordance with the manufacturer's operating instructions.



Caution, risk of electrical shock.

When operating the transducer, certain parts of the module can carry hazardous voltage (eg. primary busbar, power supply). Ignoring this warning can lead to injury and/or cause serious damage. This transducer is a build-in device, whose conducting parts must be inaccessible after installation. A protective housing or additional shield could be used. Main supply must be able to be disconnected.

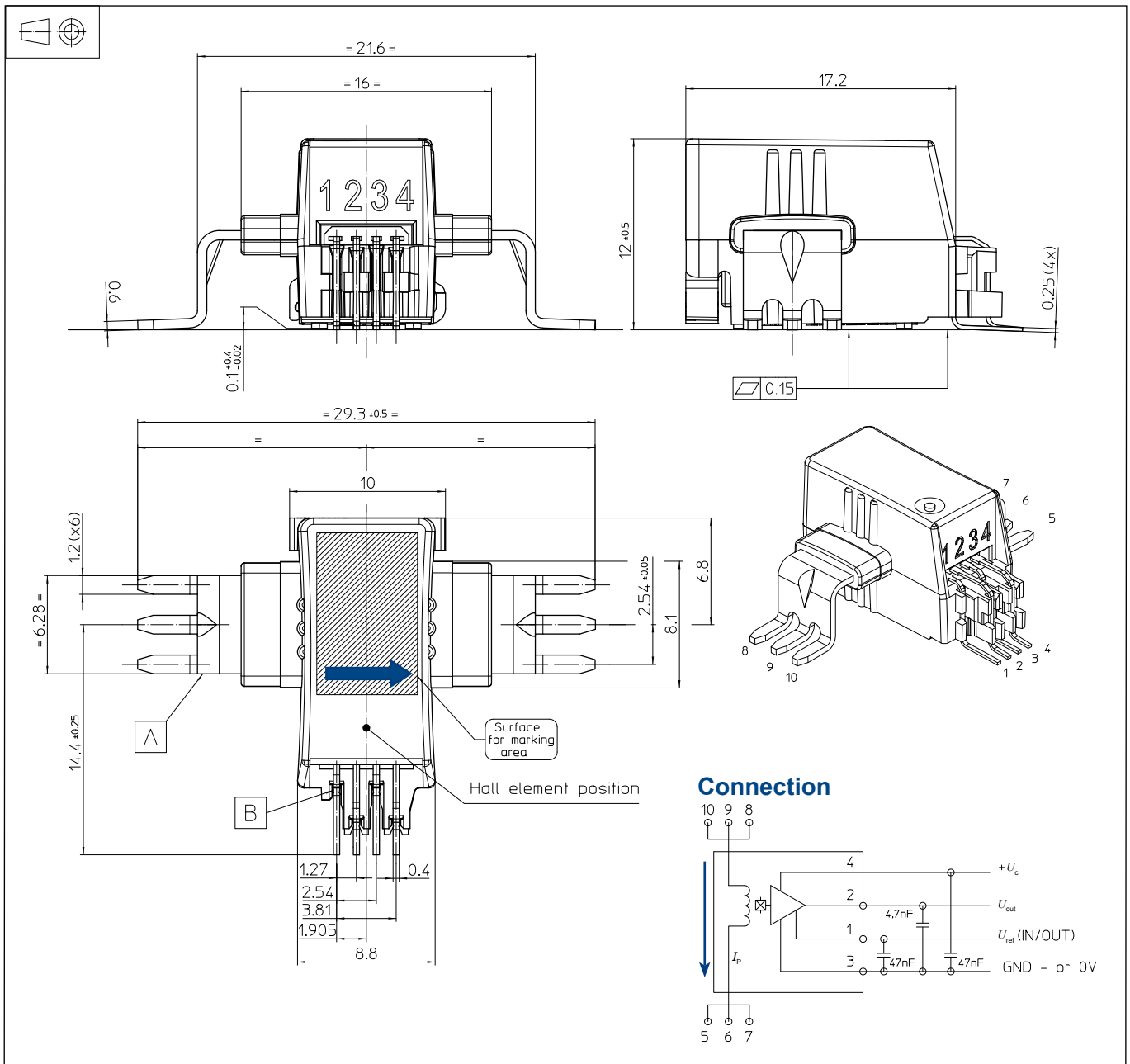
Dimensions (in mm. General linear tolerance ± 0.2 mm)

Remarks

- U_{out} is positive with respect to U_{ref} when positive I_p flows in direction of the arrow shown on the drawing above.
- Installation of the transducer must be done, unless otherwise specified on the datasheet, according to LEM Transducer Generic Mounting Rules. Please refer to LEM document N°ANE120504 available on our Web site: <https://www.lem.com/en/file/3137/download/>