

Electrostatic Discharged Protection Devices (ESD) Data Sheet

Description

The UAD8C12L01 of Transient Voltage Suppressors is designed to replace multilayer varistors (MLVs) in portable applications such as cell phones, notebook computer, and PDAs.

It offer superior electrical characteristics such as lower clamping voltage and no device degradation when compared to MLVs. It is designed to protect sensitive semiconductor components from damage or upset due to electrostatic discharge (ESD), lightning, electrical fast transients (EFT), and cable discharge events (CDE).



Contact : $\pm 20\text{kV}$

Air : $\pm 20\text{kV}$



Features

- IEC61000-4-2 ESD 20KV Air, 20KV contact compliance
- SOD882 surface mount package
- Working voltage: 12V
- Low leakage current
- Low operating and clamping voltages
- Solid-state silicon avalanche technology
- RoHS compliant
- Solder reflow temperature: Pure Tin-Sn, 260~270°C
- Flammability rating UL 94V-0
- Meets MSL level 1, per J-STD-020
- Marking: B12

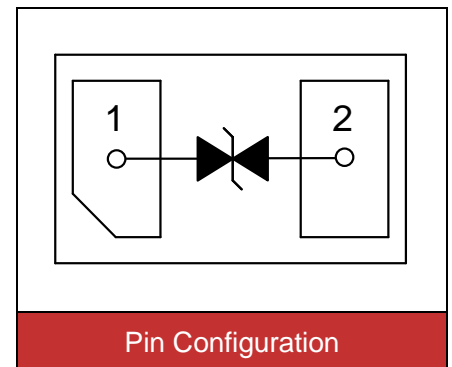

Applications

- MP3 players
- Touch Panels
- Personal digital assistants (PDA)
- Serial ATA protection
- Wireless system devices
- Handhelds and notebooks
- Digital cameras
- Portable Devices

Maximum Ratings

Rating	Symbol	Value	Unit
ESD voltage (Contact discharge)	V _{ESD}	±20	kV
ESD voltage (Air discharge)		±20	
Storage & operating temperature range	T _{STG} , T _J	-55~+150	°C

Electrical Characteristics (T_J=25°C)

Parameter	Symbol	Condition	Min.	Typ.	Max.	Unit
Reverse stand-off voltage	V _{RWM}				12	V
Reverse breakdown voltage	V _{BR}	I _{BR} =1mA	13.7			V
Reverse leakage current	I _R	V _R =12V			0.5	μA
Clamping voltage (tp=8/20μs)	V _C	I _{PP} =3A		18		V
Peak pulse current (tp=8/20μs)	I _{PP}				3	A
ESD Clamping voltage (TLP)	V _C	I _{PP} =8A		16.4		V
ESD Clamping voltage (TLP)	V _C	I _{PP} =16A		18		V
ESD Dynamic Turn-on Resistance	R _{dynamic}			0.25		Ω
Off state junction capacitance	C _J	0Vdc, f=1MHz		3.5	5.0	pF

Typical Characteristics Curves

Figure 1. Pulse Waveforms

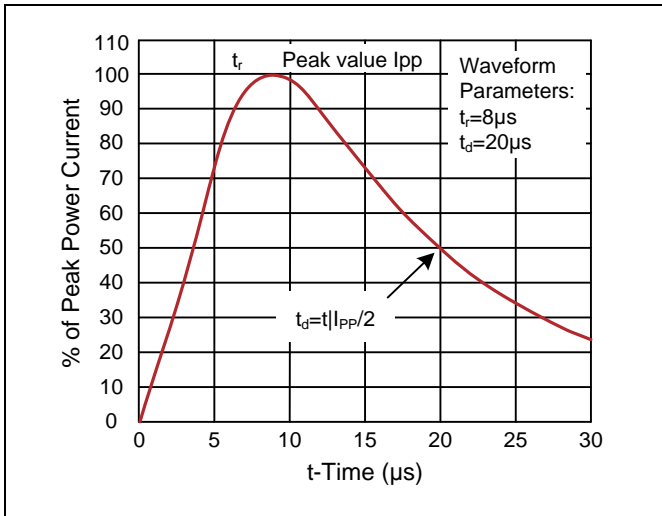

Figure 2. Clamping Voltage vs. Peak Pulse Current

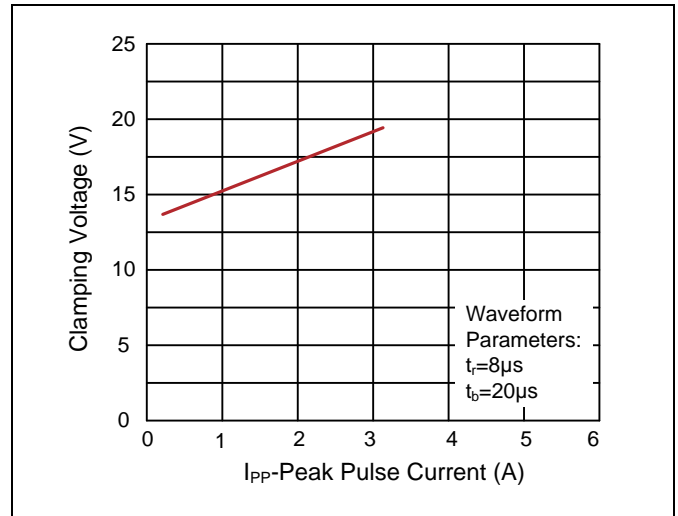

Figure 3. Capacitance vs. Reverse Voltage

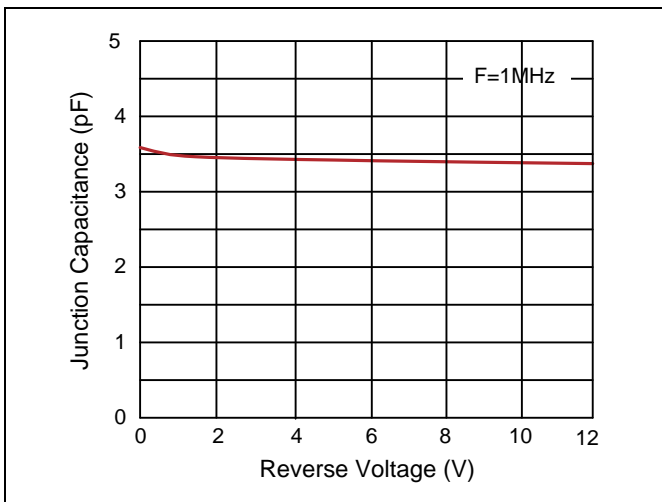

Figure 4. Power Derating Curve

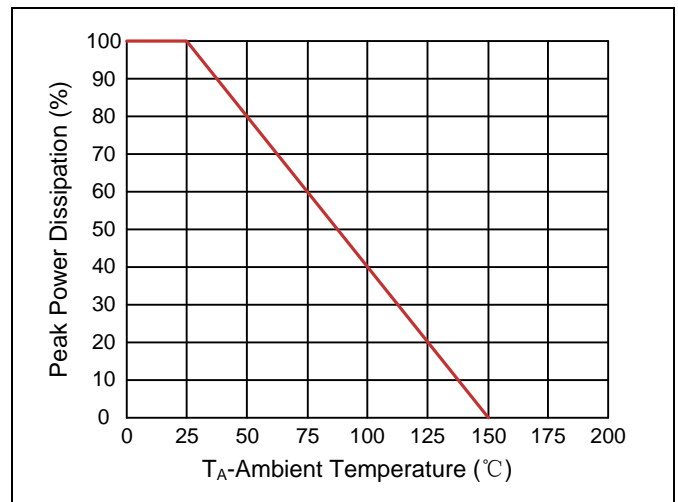

Figure 5. ESD Clamping (8kV Contact IEC61000-4-2)

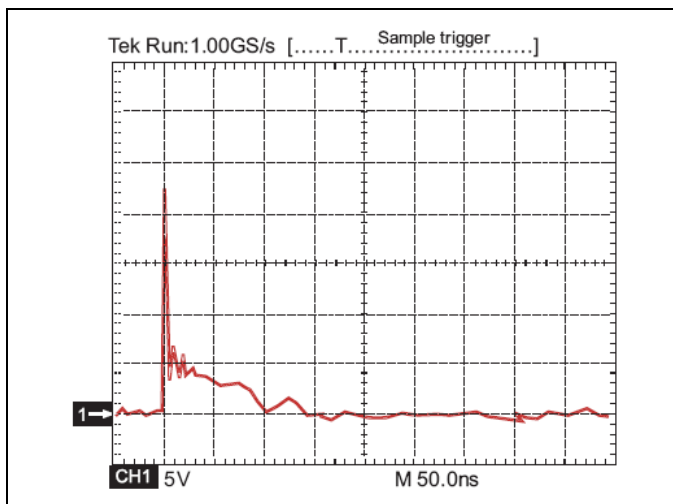
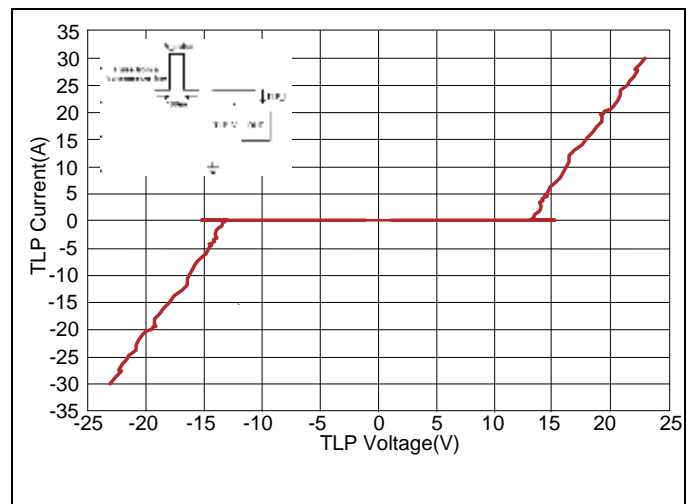

Figure 6. Transmission Line Pulsing (TLP) Measurement



Dimensions (SOD882)

	Dimension (mm)				
	Symbol	Millimeters		Inches	
		Min.	Max.	Min.	Max.
	A	0.95	1.05	0.037	0.041
B	0.55	0.65	0.022	0.026	
C	0.32	0.55	0.013	0.022	
D	0.45		0.018		
E	0.20	0.30	0.008	0.012	
F	0.45	0.55	0.018	0.022	

Packaging

<p>Tape</p>	Symbol	Dimension (mm)
	W	8.00±0.30
	P0	4.00±0.10
	P1	2.00±0.10
	P2	2.00±0.10
	D0	Φ1.55±0.10
	D1	Φ0.40±0.05
	E	1.75±0.10
	F	3.50±0.10
	A	0.75±0.10
	B	1.15±0.10
	K	0.60±0.05
	t	0.20±0.05
	<p>Reel</p>	D
D2		Φ14.4
W1		10.0
Quantity: 10000PCS		