

BSCL Series

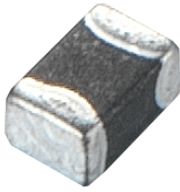

The SMD multi-layered ferrite chip inductors provide a cost-effective solution for densely packed PC board designs. BSCL series comes in 4 sizes and is suitable for low frequency applications.

Features

- RoHS compliant
- High mounting density of compact circuit due to crosstalk elimination that results from a closed magnetic flux in a ferrite material
- Suitable for flow and re-flow soldering
- Available in 4 sizes

Applications

- Personal computers, HDDs, other various electronic devices
- Any portable device where compact size and high mounting densities are required

Product Identification

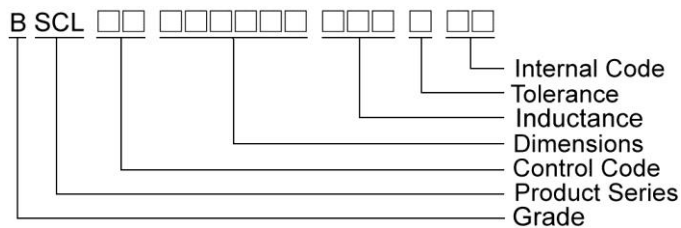

Shape and Dimensions

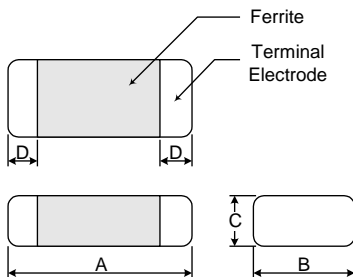

Recommended Pattern

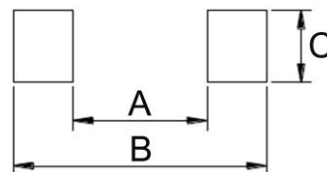

Dimensions in mm

TYPE	A	B	C	D
BSCL00160808	1.6±0.20	0.80±0.20	0.80±0.20	0.3±0.20
BSCL00201209	2.0±0.20	1.25±0.20	0.90±0.20	0.5±0.30
BSCL00201212	2.0±0.20	1.25±0.20	1.25±0.20	0.5±0.30
BSCL00321611	3.2±0.20	1.60±0.20	1.10±0.20	0.5±0.30

Dimensions in mm

TYPE	A	B	C
BSCL00160808	0.7 ~ 0.8	1.8 ~ 2.0	0.6 ~ 0.8
BSCL00201209	1.0 ~ 1.2	2.6 ~ 4.0	1.0 ~ 1.4
BSCL00201212	1.0 ~ 1.2	2.6 ~ 4.0	1.0 ~ 1.2
BSCL00321611	2.0 ~ 2.4	4.2 ~ 5.2	1.3 ~ 1.9

SMD Multilayer Ferrite Chip Inductors – BSCL Series

Electrical Characteristics

Part Number	Inductance (μ H)	Tolerance ($\pm\%$)	Q Min	Test Frequency (MHz)	SRF (MHz) Min	RDC (Ω) Max	IDC (mA) Max
BSCL0016080810N□00	0.010	20	15	50	300	0.2	50
BSCL0016080833N□00	0.033	20	15	50	270	0.2	50
BSCL0016080847N□00	0.047	20	15	50	260	0.3	50
BSCL0016080856N□00	0.056	20	15	50	255	0.3	50
BSCL0016080868N□00	0.068	20	15	50	250	0.3	50
BSCL0016080882N□00	0.082	20	15	50	245	0.3	50
BSCL00160808R10□00	0.10	20 / 15 / 10	25	25	240	0.5	50
BSCL00160808R12□00	0.12	20 / 15 / 10	25	25	205	0.5	50
BSCL00160808R15□00	0.15	20 / 15 / 10	25	25	180	0.6	50
BSCL00160808R18□00	0.18	20 / 15 / 10	25	25	165	0.6	50
BSCL00160808R22□00	0.22	20 / 15 / 10	25	25	150	0.8	50
BSCL00160808R27□00	0.27	20 / 15 / 10	25	25	136	0.8	50
BSCL00160808R33□00	0.33	20 / 15 / 10	25	25	125	0.85	35
BSCL00160808R39□00	0.39	20 / 15 / 10	25	25	110	1.00	35
BSCL00160808R47□00	0.47	20 / 15 / 10	25	25	105	1.35	35
BSCL00160808R56□00	0.56	20 / 15 / 10	25	25	95	1.50	35
BSCL00160808R68□00	0.68	20 / 15 / 10	25	25	85	1.70	35
BSCL00160808R82□00	0.82	20 / 15 / 10	25	25	75	2.10	35
BSCL001608081R0□00	1.0	20 / 15 / 10	35	10	65	0.60	25
BSCL001608081R2□00	1.2	20 / 15 / 10	35	10	60	0.80	25
BSCL001608081R5□00	1.5	20 / 15 / 10	35	10	55	0.80	25
BSCL001608081R8□00	1.8	20 / 15 / 10	35	10	50	0.95	25
BSCL001608082R2□00	2.2	20 / 15 / 10	35	10	45	1.00	15
BSCL001608082R7□00	2.7	20 / 15 / 10	35	10	40	1.15	15
BSCL001608083R3□00	3.3	20 / 15 / 10	35	10	38	1.30	15
BSCL001608083R9□00	3.9	20 / 15 / 10	35	10	36	1.50	15
BSCL001608084R7□00	4.7	20 / 15 / 10	35	10	33	1.60	15
BSCL001608085R6□00	5.6	20 / 15 / 10	35	4	22	1.10	5
BSCL001608086R8□00	6.8	20 / 15 / 10	35	4	20	1.30	5
BSCL001608088R2□00	8.2	20 / 15 / 10	30	4	18	1.50	5
BSCL00160808100□00	10	20 / 15 / 10	30	2	17	1.70	5
BSCL00160808120□00	12	20 / 15 / 10	30	2	15	1.80	3
BSCL00160808150□00	15	20 / 15 / 10	20	1	14	1.50	1
BSCL00160808220□00	22	20 / 15 / 10	20	1	11	1.70	1

Note: When ordering, please specify tolerance code. Tolerance : K=±10% , L=±15% , M=±20%

- Operating temperature range - 40°C ~ 125°C(Including self - temperature rise)
- IDC : Applied the current to coils, the inductance shall be less than 10% initial value
- Measure Equipment :
L & Q : HP4291A
SRF : Agilent HP8753D/Agilent E4991A
RDC : HP4338B or CHEN HWA 502

Please be sure to request approval specifications that provide further details of the products. Kindly note that the content of these specifications are subject to change or may be discontinued without prior notice. This product may not be designed/used in medical or high risk applications without Chilisin approval. Please contact our sales department before ordering.

SMD Multilayer Ferrite Chip Inductors – BSCL Series

Electrical Characteristics

Part Number	Inductance (μ H)	Tolerance (\pm %)	Q Min	Test Frequency (MHz)	SRF MHz Min	RDC (Ω) Max	IDC (mA) Max
BSCL0020120922N□00	0.022	20	20	50	320	0.20	300
BSCL0020120933N□00	0.033	20 / 15	20	50	320	0.20	300
BSCL0020120947N□00	0.047	20 / 15	20	50	320	0.20	300
BSCL0020120956N□00	0.056	20 / 15	20	50	320	0.20	300
BSCL0020120968N□00	0.068	20 / 15	20	50	280	0.20	300
BSCL0020120982N□00	0.082	20 / 15	20	50	255	0.20	300
BSCL00201209R10□00	0.10	20 / 15 / 10	25	25	235	0.30	250
BSCL00201209R12□00	0.12	20 / 15 / 10	25	25	220	0.30	250
BSCL00201209R15□00	0.15	20 / 15 / 10	25	25	200	0.40	250
BSCL00201209R18□00	0.18	20 / 15 / 10	25	25	185	0.40	250
BSCL00201209R22□00	0.22	20 / 15 / 10	25	25	170	0.50	250
BSCL00201209R27□00	0.27	20 / 15 / 10	25	25	150	0.50	250
BSCL00201209R33□00	0.33	20 / 15 / 10	25	25	145	0.55	250
BSCL00201209R39□00	0.39	20 / 15 / 10	25	25	135	0.65	250
BSCL00201209R47□00	0.47	20 / 15 / 10	25	25	125	0.65	250
BSCL00201209R56□00	0.56	20 / 15 / 10	25	25	115	0.75	150
BSCL00201209R68□00	0.68	20 / 15 / 10	25	25	105	0.80	150
BSCL00201209R82□00	0.82	20 / 15 / 10	25	25	100	1.00	150
BSCL002012091R0□00	1.0	20 / 15 / 10	45	10	75	0.40	50
BSCL002012091R2□00	1.2	20 / 15 / 10	45	10	65	0.50	50
BSCL002012091R5□00	1.5	20 / 15 / 10	45	10	60	0.50	50
BSCL002012091R8□00	1.8	20 / 15 / 10	45	10	55	0.60	50
BSCL002012092R2□00	2.2	20 / 15 / 10	45	10	50	0.65	30

Note: When ordering, please specify tolerance code. Tolerance : K= \pm 10% , L= \pm 15% , M= \pm 20%

- Operating temperature range - 40°C ~ 125°C(Including self - temperature rise)
- IDC : Applied the current to coils, the inductance shall be less than 10% initial value
- Measure Equipment :
L & Q : HP4291A
SRF : Agilent HP8753D/Agilent E4991A
RDC : HP4338B or CHEN HWA 502

SMD Multilayer Ferrite Chip Inductors – BSCL Series

Electrical Characteristics

Part Number	Inductance	Tolerance	Q	Test Frequency	SRF	RDC	IDC
	(μ H)	(\pm %)	Min	(MHz)	(MHz) Min	(Ω) Max	(mA) Max
BSCL002012122R7□00	2.7	20 / 15 / 10	45	10	45	0.75	30
BSCL002012123R3□00	3.3	20 / 15 / 10	45	10	41	0.80	30
BSCL002012123R9□00	3.9	20 / 15 / 10	45	10	38	0.90	30
BSCL002012124R7□00	4.7	20 / 15 / 10	45	10	35	1.00	30
BSCL002012125R6□00	5.6	20 / 15 / 10	45	4	32	0.90	15
BSCL002012126R8□00	6.8	20 / 15 / 10	45	4	29	1.00	15
BSCL002012128R2□00	8.2	20 / 15 / 10	45	4	26	1.10	15
BSCL00201212100□00	10	20 / 15 / 10	45	2	24	1.10	15
BSCL00201212120□00	12	20 / 15 / 10	45	2	22	1.20	15
BSCL00201212150□00	15	20 / 15 / 10	30	1	19	0.80	5
BSCL00201212180□00	18	20 / 15 / 10	30	1	18	0.90	5
BSCL00201212220□00	22	20 / 15 / 10	30	1	16	1.1	5

Note: When ordering, please specify tolerance code. Tolerance : K= \pm 10% , L= \pm 15% , M= \pm 20%

- Operating temperature range - 40°C ~ 125°C(Including self - temperature rise)
- IDC : Applied the current to coils, the inductance shall be less than 10% initial value
- Measure Equipment :
L & Q : HP4291A
SRF : Agilent HP8753D/Agilent E4991A
RDC : HP4338B or CHEN HWA 502

SMD Multilayer Ferrite Chip Inductors – BSCL Series

Electrical Characteristics

Part Number	Inductance (μ H)	Tolerance (\pm %)	Q Min	Test Frequency (MHz)	SRF (MHz) Min	RDC (Ω) Max	IDC (mA) Max
BSCL0032161147N□00	0.047	20	20	50	320	0.15	300
BSCL0032161156N□00	0.056	20	20	50	280	0.25	300
BSCL0032161168N□00	0.068	20	20	50	280	0.25	300
BSCL0032161182N□00	0.082	20	20	50	250	0.25	300
BSCL00321611R10□00	0.10	20 / 15 / 10	25	25	235	0.25	250
BSCL00321611R12□00	0.12	20 / 15 / 10	25	25	220	0.30	250
BSCL00321611R15□00	0.15	20 / 15 / 10	25	25	200	0.30	250
BSCL00321611R18□00	0.18	20 / 15 / 10	25	25	185	0.40	250
BSCL00321611R22□00	0.22	20 / 15 / 10	25	25	170	0.40	250
BSCL00321611R27□00	0.27	20 / 15 / 10	25	25	150	0.50	250
BSCL00321611R33□00	0.33	20 / 15 / 10	25	25	145	0.60	250
BSCL00321611R39□00	0.39	20 / 15 / 10	25	25	135	0.50	200
BSCL00321611R47□00	0.47	20 / 15 / 10	25	25	125	0.60	200
BSCL00321611R56□00	0.56	20 / 15 / 10	25	25	115	0.70	150
BSCL00321611R68□00	0.68	20 / 15 / 10	25	25	105	0.80	150
BSCL00321611R82□00	0.82	20 / 15 / 10	25	25	100	0.90	150
BSCL00321611R100□00	1.0	20 / 15 / 10	45	10	75	0.40	100
BSCL00321611R120□00	1.2	20 / 15 / 10	45	10	65	0.50	100
BSCL00321611R150□00	1.5	20 / 15 / 10	45	10	60	0.50	80
BSCL00321611R180□00	1.8	20 / 15 / 10	45	10	55	0.50	70
BSCL00321611R220□00	2.2	20 / 15 / 10	45	10	50	0.60	60
BSCL00321611R270□00	2.7	20 / 15 / 10	45	10	45	0.60	60
BSCL00321611R330□00	3.3	20 / 15 / 10	45	10	41	0.70	60
BSCL00321611R390□00	3.9	20 / 15 / 10	45	10	38	0.80	50
BSCL00321611R470□00	4.7	20 / 15 / 10	45	10	35	0.90	50
BSCL00321611R560□00	5.6	20 / 15 / 10	45	4	32	0.70	25
BSCL00321611R680□00	6.8	20 / 15 / 10	45	4	29	0.80	25
BSCL00321611R820□00	8.2	20 / 15 / 10	45	4	26	0.90	25
BSCL00321611100□00	10	20 / 15 / 10	45	2	24	1.00	25
BSCL00321611120□00	12	20 / 15 / 10	45	2	22	1.00	15
BSCL00321611150□00	15	20 / 15 / 10	35	1	19	0.70	5
BSCL00321611180□00	18	20 / 15 / 10	35	1	18	0.75	5
BSCL00321611220□00	22	20 / 15 / 10	35	1	16	0.90	5
BSCL00321611270□00	27	20 / 15 / 10	35	1	14	0.90	5

Note: When ordering, please specify tolerance code. Tolerance : K= \pm 10% , L= \pm 15% , M= \pm 20%

- Operating temperature range - 40°C ~ 125°C(Including self - temperature rise)
- IDC : Applied the current to coils, the inductance shall be less than 10% initial value
- Measure Equipment :
L & Q : HP4291A
SRF : Agilent HP8753D/Agilent E4991A
RDC : HP4338B or CHEN HWA 502

Please be sure to request approval specifications that provide further details of the products. Kindly note that the content of these specifications are subject to change or may be discontinued without prior notice. This product may not be designed/used in medical or high risk applications without Chilisin approval. Please contact our sales department before ordering.

SMD Multilayer Ferrite Chip Inductors – BSCL Series

Test Instruments : Agilent E4991A Impedance / Material Analyzer

BSCL00160808

INDUCTANCE vs. FREQUENCY CHARACTERISTICS

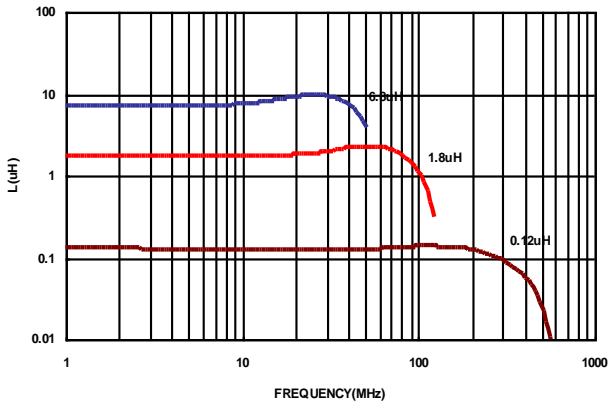

Q vs. FREQUENCY CHARACTERISTICS

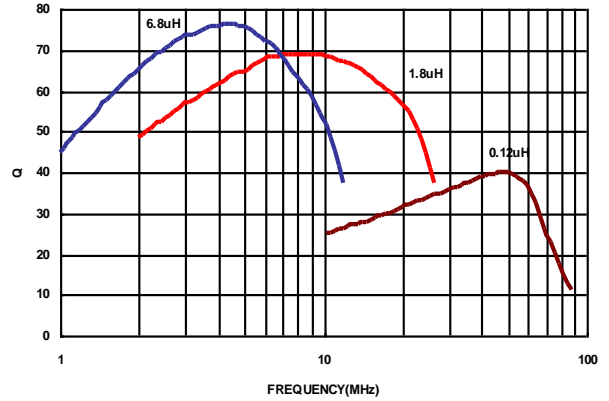

BSCL00201209

INDUCTANCE vs. FREQUENCY CHARACTERISTICS

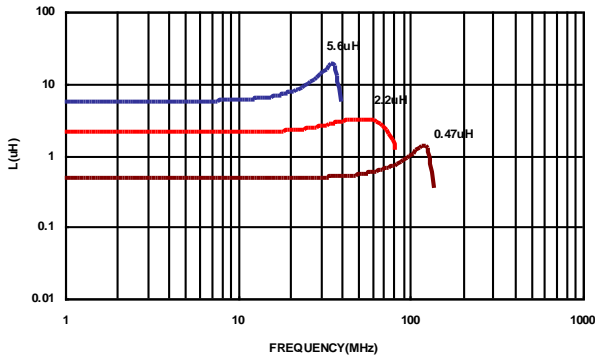

Q vs. FREQUENCY CHARACTERISTICS



BSCL00321611

INDUCTANCE vs. FREQUENCY CHARACTERISTICS

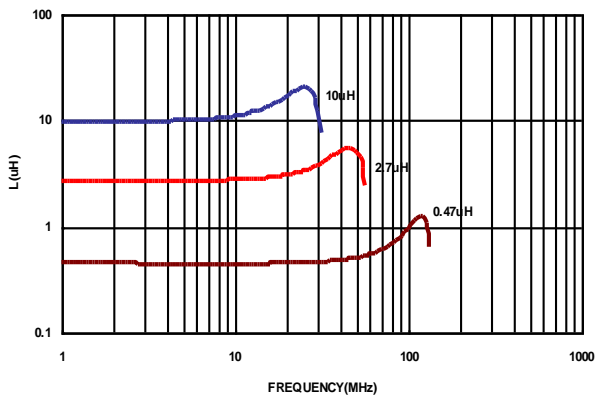

Q vs. FREQUENCY CHARACTERISTICS

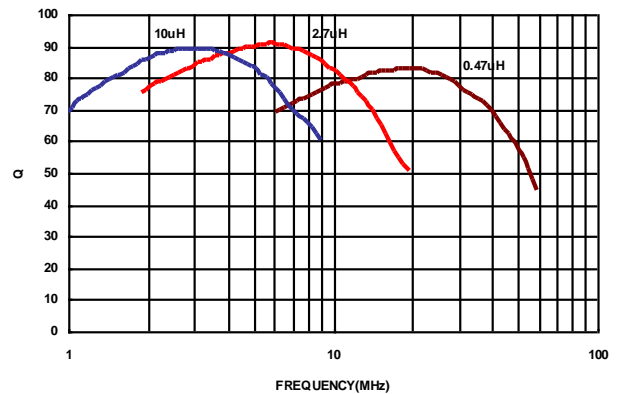

Please be sure to request approval specifications that provide further details of the products. Kindly note that the content of these specifications are subject to change or may be discontinued without prior notice. This product may not be designed/used in medical or high risk applications without Chilisin approval. Please contact our sales department before ordering.

SMD Multilayer Ferrite Chip Inductors - BSCL Series

Packaging Specifications

Tape Dimensions

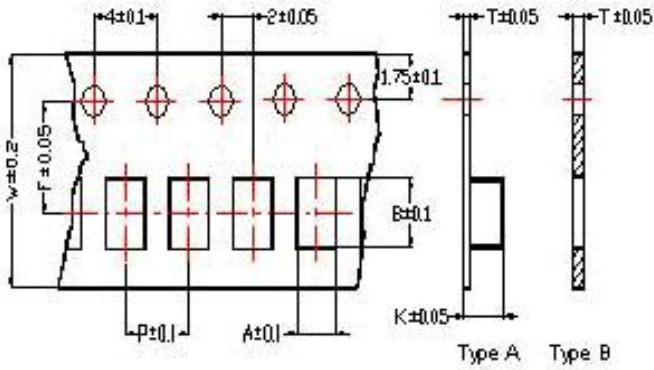

Tape Material

Carrier Tape: Polycarbonate (Tape A)
 Carrier Tape: Paper (Tape B)
 Cover Tape: Polystyrene

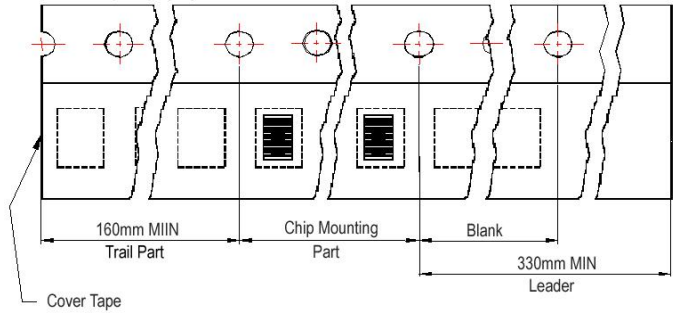

Reel Dimensions

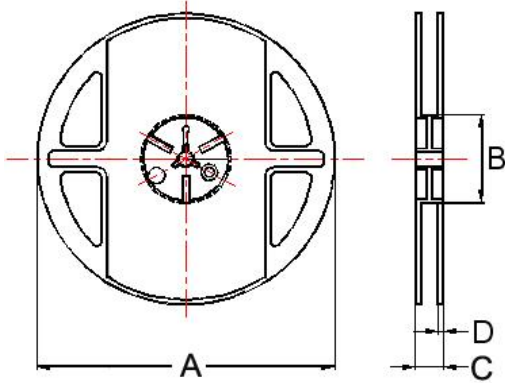

Dimensions in mm

TYPE	Tape Dimensions								Reel Dimensions				Quantity PCS / Reel
	A	B	T	W	P	F	K	Tape	A	B	C	D	
BSCL00160808	1.05	1.85	0.95	8.0	4.0	3.5	-	B	178	60	12	1.5	4000
BSCL00201209	1.50	2.30	0.97	8.0	4.0	3.5	-	B	178	60	12	1.5	4000
BSCL00201212	1.35	2.25	0.22	8.0	4.0	3.5	1.35	A	178	60	12	1.5	3000
BSCL00321611	1.88	3.50	0.22	8.0	4.0	3.5	1.27	A	178	60	12	1.5	3000