

## Technical Data Sheet Top View LEDs

### 67-22/R6Y2C-B31/2T

#### Features

- .P-LCC-4 package
- .Optical indicator
- .Colorless clear window
- .Ideal for backlight and light pipe application
- .Inter reflector
- .Wide viewing angle
- .Suitable for vapor-phase reflow.
- .Computable with automatic placement equipment
- .Available on tape and reel (8mm Tape)
- .Pb-free
- .The product itself will remain within RoHS compliant version



#### Descriptions

.The 67-22 series is available in soft orange, green, blue and yellow. Due to the package design, the LED has wide viewing angle and optimized light coupling by inter reflector. This feature makes ideal for light pipe application. The low current requirement makes this device ideal for portable equipment or any other application where power is at a premium.

#### Applications

- .Telecommunication: indicator and backlighting in telephone and fax
- .Flat backlight for LCD's, switches and symbols
- .Light pipe application
- .General use

#### Device Selection Guide

Chip		Emitted Color	Resin Color
Type	Material		
R6	AlGaInP	Brilliant Red	Water Clear
Y2	AlGaInP	Brilliant Yellow	

Technical Data Sheet  
Top View LEDs

**67-22/R6Y2C-B31/2T**

Package Dimensions

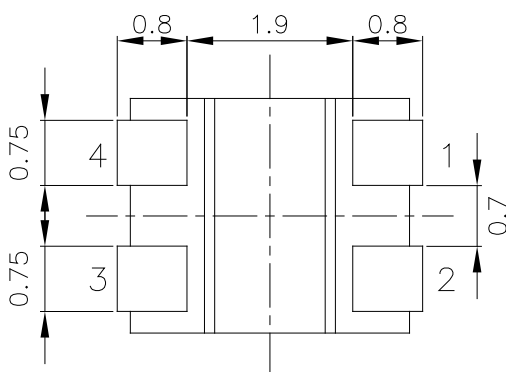
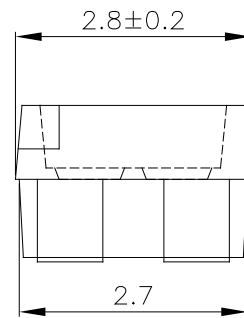
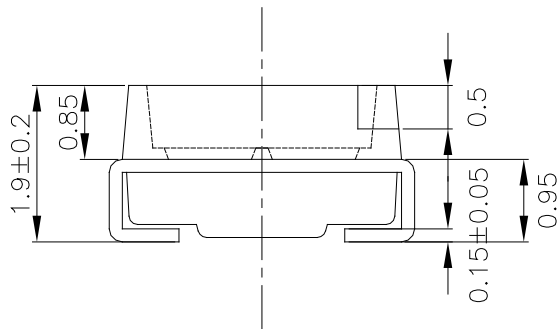
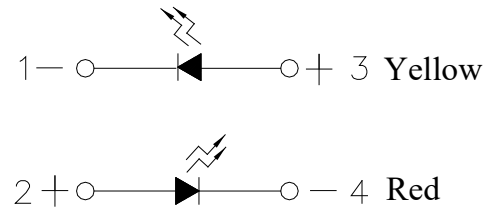
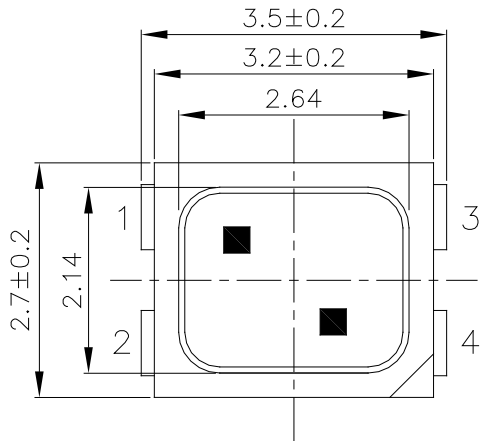

Recommended Solder Pad

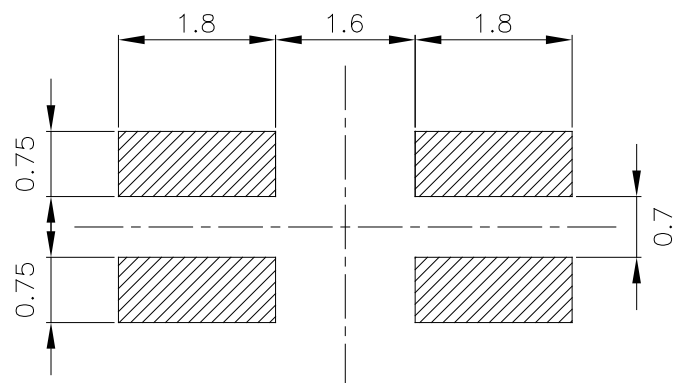

**Note:** The tolerance unless mentioned is  $\pm 0.1\text{mm}$ .

**Technical Data Sheet**  
**Top View LEDs**

**67-22/R6Y2C-B31/2T**

**Absolute Maximum Ratings (Ta=25°C)**

Parameter	Symbol	Rating	Unit
Reverse Voltage	V <sub>R</sub>	5	V
Forward Current	I <sub>F</sub>	R6	25
		Y2	25
Peak Forward Current(Duty 1/10 @ 1KHz)	I <sub>FP</sub>	R6	60
		Y2	60
Power Dissipation	P <sub>d</sub>	R6	60
		Y2	60
Electrostatic Discharge(HBM)	ESD	R6	2000
		Y2	2000
Operating Temperature	Topr	-40 ~ +85	°C
Storage Temperature	Tstg	-40~ +95	°C
Soldering Temperature	Tsol	Reflow soldering : 260 °C for 10 sec. Hand soldering : 350 °C for 3 sec.	

**Technical Data Sheet**  
**Top View LEDs**

**67-22/R6Y2C-B31/2T**

**Electro-Optical Characteristics (Ta=25°C)**

Parameter	Symbol	Min.	Typ.	Max.	Unit	Condition
Luminous Intensity	I <sub>v</sub>	R6	72	-----	285	I <sub>F</sub> =20mA
		Y2		-----		
Viewing Angle	2θ <sub>1/2</sub>	-----	120	-----	deg	
Peak Wavelength	λ <sub>p</sub>	R6	-----	632	-----	
		Y2	-----	591	-----	
Dominant Wavelength	λ <sub>d</sub>	R6	621	-----	631	
		Y2	586	-----	594	
Spectrum Radiation Bandwidth	Δλ	R6	-----	20	-----	
		Y2	-----	15	-----	
Forward Voltage	V <sub>F</sub>	R6	1.75	-----	2.35	
		Y2				
Reverse Current	I <sub>R</sub>	R6	-----	-----	10	μA
		Y2				

**Notes:**

1. Tolerance of Luminous Intensity : ±11%
2. Tolerance of Dominant Wavelength : ±1nm
3. Tolerance of Forward Voltage : ±0.1V

**Bin Range of Luminous Intensity**

**Technical Data Sheet  
Top View LEDs**

**67-22/R6Y2C-B31/2T**

Symbol	Bin Code	Min.	Max.	Unit	Condition
R6	Q1	72	90	mcd	I <sub>F</sub> =20mA
	Q2	90	112		
	R1	112	140		
	R2	140	180		
	S1	180	225		
	S2	225	285		
Y2	Q1	72	90		
	Q2	90	112		
	R1	112	140		
	R2	140	180		
	S1	180	225		
	S2	225	285		

**Bin Range of Dominant Wavelength**

Symbol	Bin Code	Min.	Max.	Unit	Condition
R6	FF1	621	626	nm	I <sub>F</sub> =20mA
	FF2	626	631		
Y2	DD1	586	588		
	DD2	588	590		
	DD3	590	592		
	DD4	592	594		

**Notes:**

1. Tolerance of Luminous Intensity : ±11%
2. Tolerance of Dominant Wavelength : ±1nm

# EVERLIGHT ELECTRONICS CO., LTD. **EVERLIGHT**

## Technical Data Sheet

### Top View LEDs

### 67-22/R6Y2C-B31/2T

#### Typical Electro-Optical Characteristics Curve (R6)

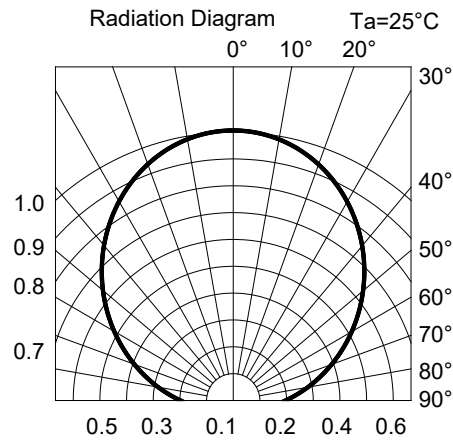
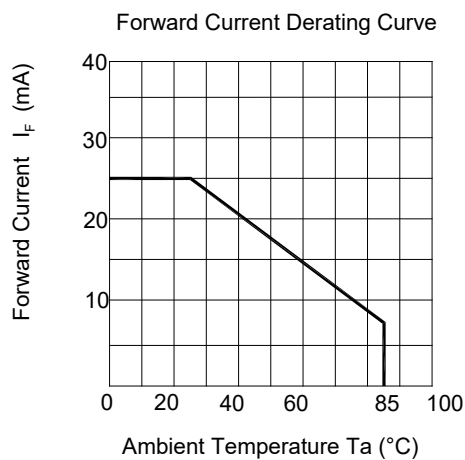
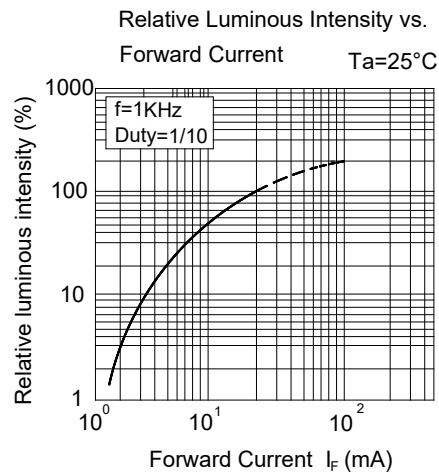
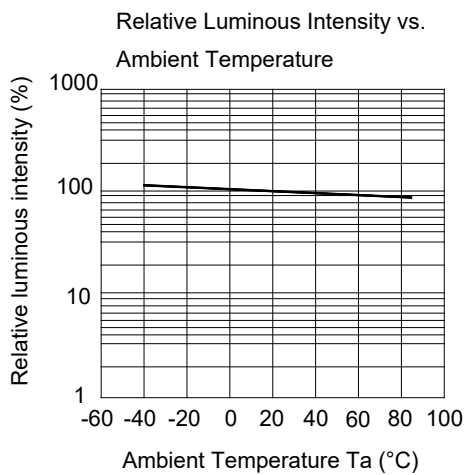
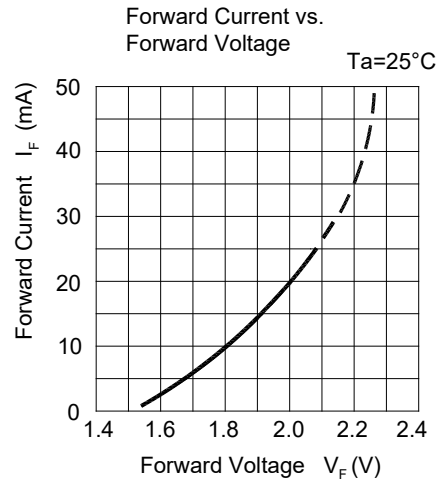
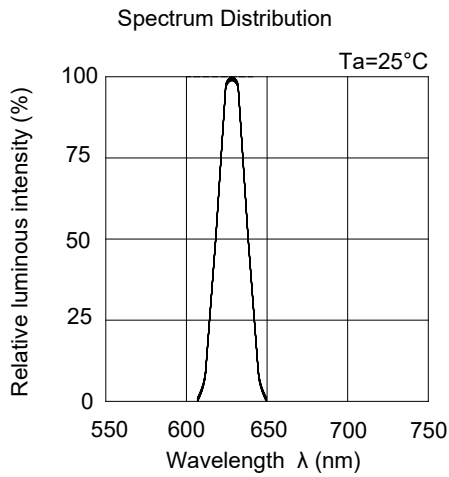

## Technical Data Sheet Top View LEDs

### 67-22/R6Y2C-B31/2T

#### Typical Electro-Optical Characteristics Curves (Y2)

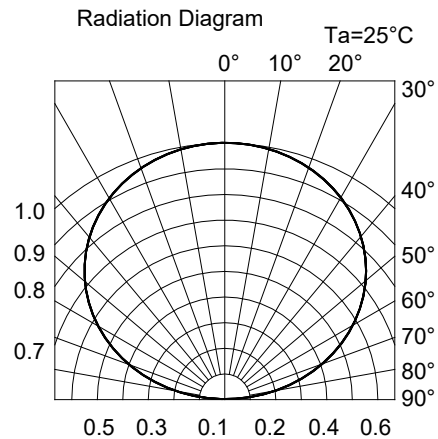
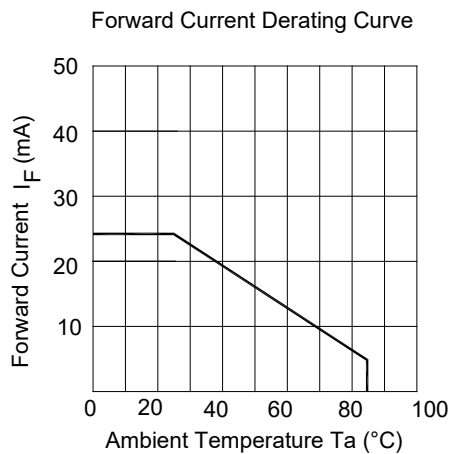
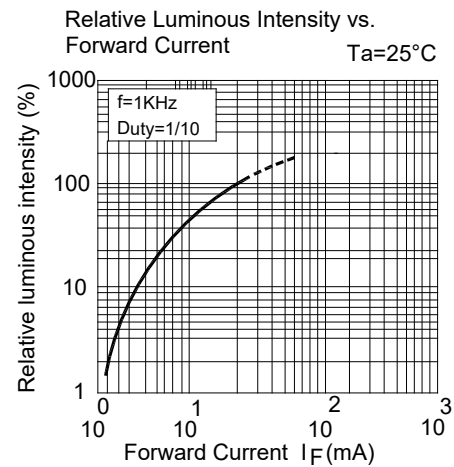
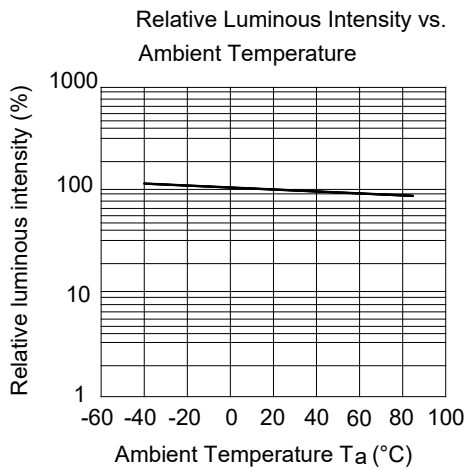
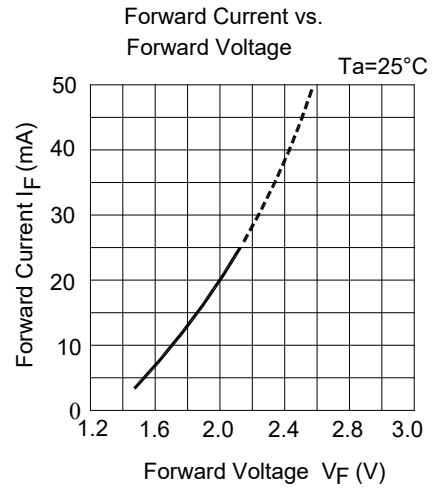
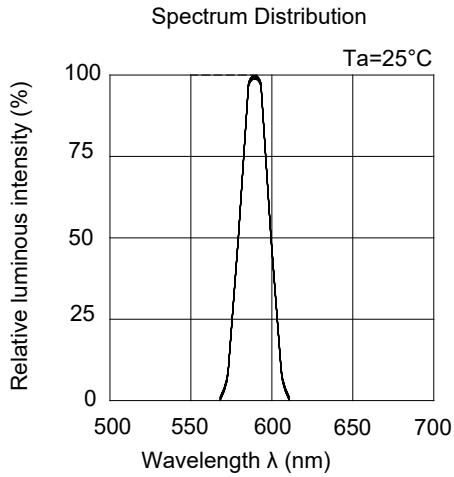

Technical Data Sheet  
Top View LEDs

**67-22/R6Y2C-B31/2T**

**Label Explanation**

- CAT: Luminous Intensity Rank
- HUE: Dom. Wavelength Rank
- REF: Forward Voltage Rank

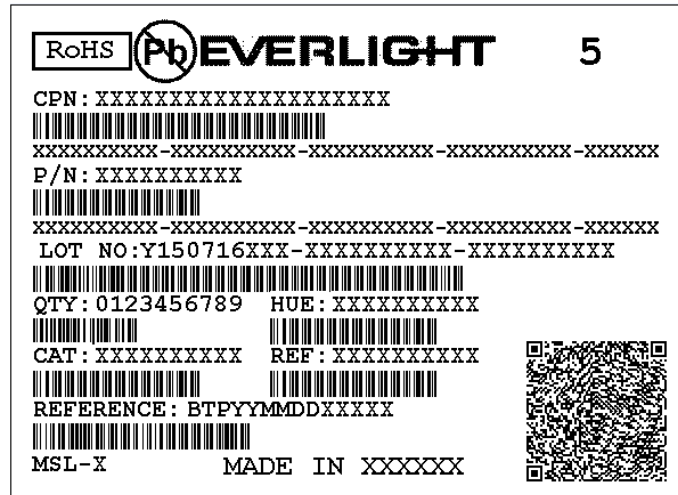

**Reel Dimensions**

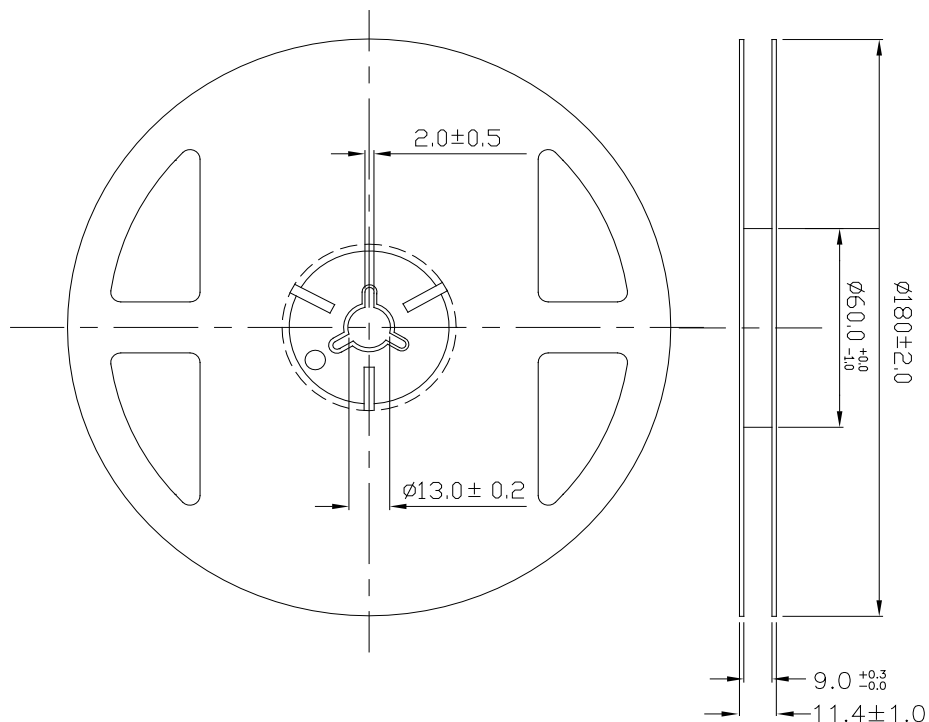

**Note:** The tolerance unless mentioned is  $\pm 0.1$ mm.



## Technical Data Sheet Top View LEDs

### 67-22/R6Y2C-B31/2T

**Carrier Tape Dimensions: Loaded Quantity 2000 pcs Per Reel**

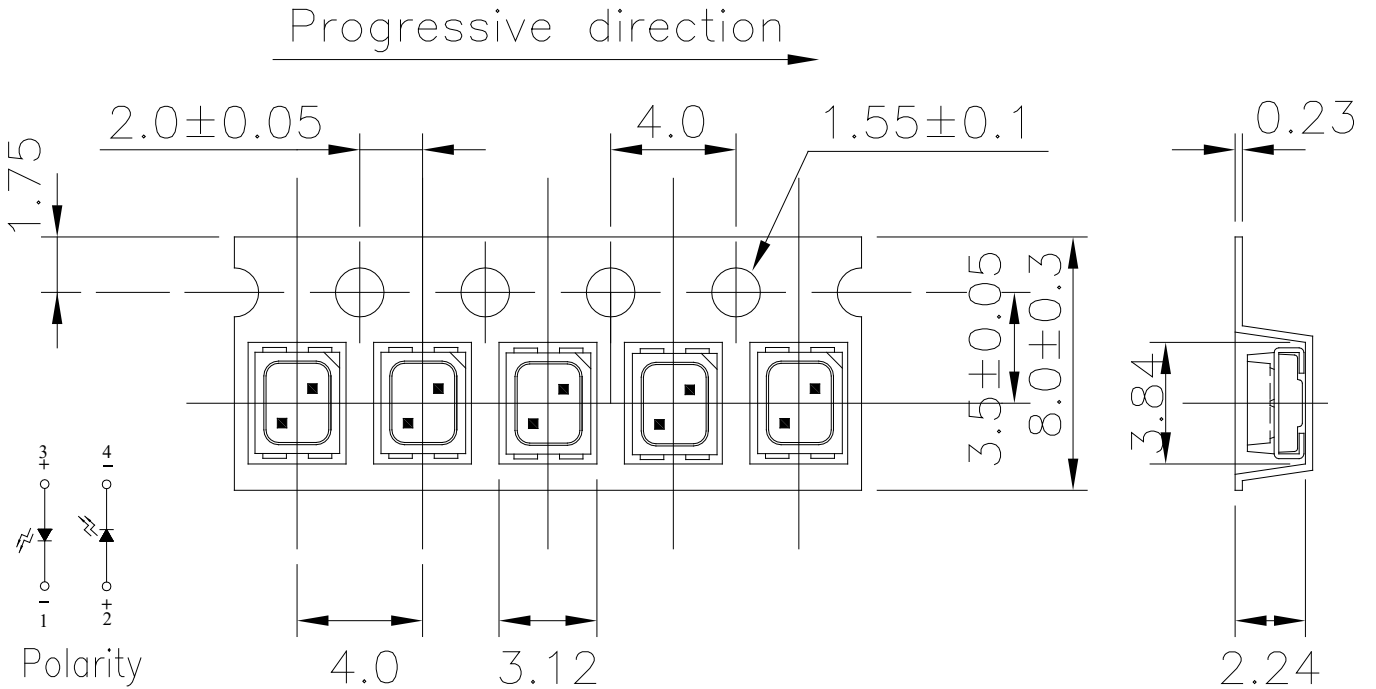

**Note:** The tolerance unless mentioned is  $\pm 0.1$ mm.

### Moisture Resistant Packaging

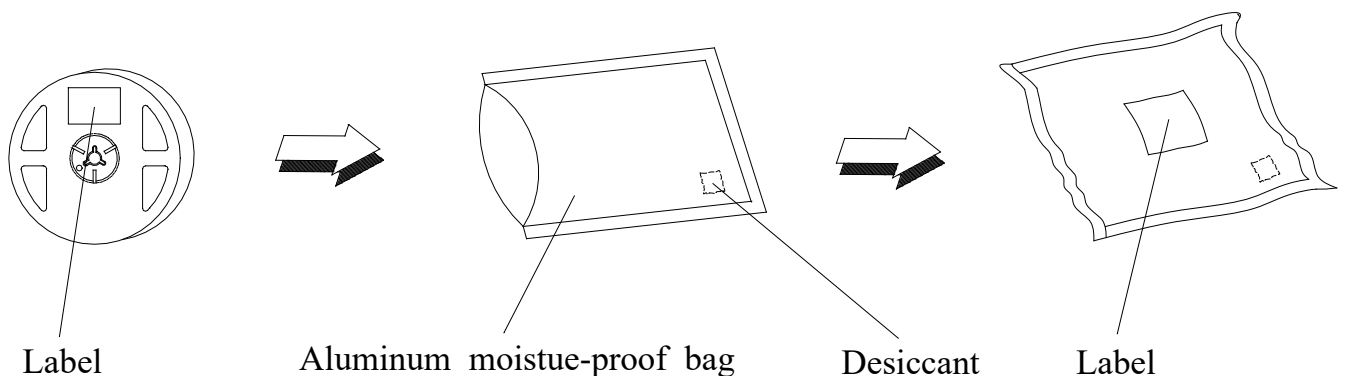

# EVERLIGHT ELECTRONICS CO., LTD. **EVERLIGHT**

## Technical Data Sheet

### Top View LEDs

---

**67-22/R6Y2C-B31/2T**

#### Precautions for Use

##### 1. Over-current-proof

1.1 Customer must apply resistors for protection, otherwise slight voltage shift will cause big current change ( Burn out will happen ).

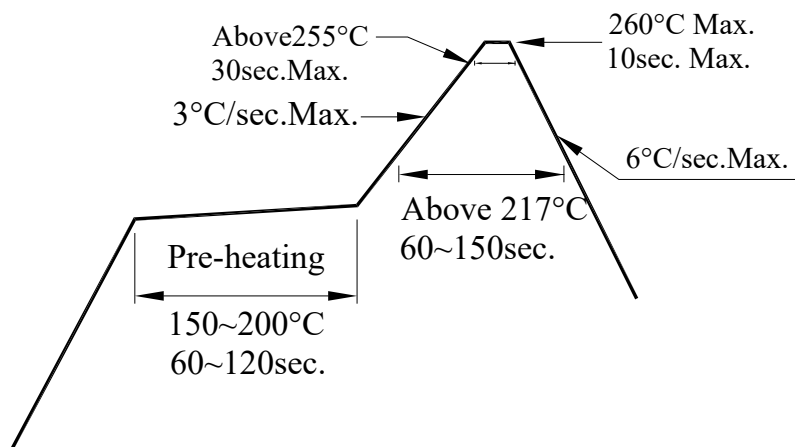

##### 2. Storage

2.1 Do not open moisture proof bag before the products are ready to use.

2.2 Before opening the package: The LEDs should be kept at 30°C or less and 90%RH or less.

2.3 After opening the package: The LED's floor life is 168 hours under 30°C or less and 60% RH or less.

If unused LEDs remain, it should be stored in moisture proof packages.

2.4 If the moisture absorbent material (silica gel) has faded away or the LEDs have exceeded the storage time, baking treatment should be performed using the following conditions.

Baking treatment : 60±5°C for 24 hours.

##### 3. Soldering Condition

3.1 Pb-free solder temperature profile

3.2 Reflow soldering should not be done more than two times.

3.3 When soldering, do not put stress on the LEDs during heating.

3.4 After soldering, do not warp the circuit board.

# EVERLIGHT ELECTRONICS CO., LTD. **EVERLIGHT**

## Technical Data Sheet

### Top View LEDs

---

#### 67-22/R6Y2C-B31/2T

#### 4. Soldering Iron

Each terminal is to go to the tip of soldering iron temperature less than 350°C for 3 seconds within once in less than the soldering iron capacity 25W. Leave two seconds and more intervals, and do soldering of each terminal. Be careful because the damage of the product is often started at the time of the hand solder.

#### 5. Repairing

Repair should not be done after the LEDs have been soldered. When repairing is unavoidable, a double-head soldering iron should be used (as below figure). It should be confirmed beforehand whether the characteristics of the LEDs will or will not be damaged by repairing.

### Application Restrictions

High reliability applications such as military/aerospace, automotive safety/security systems, and medical equipment may require different product. If you have any concerns, please contact Everlight before using this product in your application. This specification guarantees the quality and performance of the product as an individual component. Do not use this product beyond the specification described in this document.

# EVERLIGHT ELECTRONICS CO., LTD. **EVERLIGHT**

## Technical Data Sheet

### Top View LEDs

---

**67-22/R6Y2C-B31/2T**

### DISCLAIMER

1. EVERLIGHT reserves the right(s) on the adjustment of product material mix for the specification.
2. The product meets EVERLIGHT published specification for a period of twelve (12) months from date of shipment.
3. The graphs shown in this datasheet are representing typical data only and do not show guaranteed values.
4. When using this product, please observe the absolute maximum ratings and the instructions for using outlined in these specification sheets. EVERLIGHT assumes no responsibility for any damage resulting from the use of the product which does not comply with the absolute maximum ratings and the instructions included in these specification sheets.
5. These specification sheets include materials protected under copyright of EVERLIGHT. Reproduction in any form is prohibited without obtaining EVERLIGHT's prior consent.
6. This product is not intended to be used for military, aircraft, automotive, medical, life sustaining or life saving applications or any other application which can result in human injury or death. Please contact authorized Everlight sales agent for special application request.

### Revision History

Rev.	Modified date	File modified contents
1	2007/08/22	New Spec
2	2016/08/25	To add the QR code
3	2016/11/25	To add the Disclaimer