

S-SODZ ***A -SH Series

GLASS PASSIVATED JUNCTION Zener voltage regulator diodes
1.0 Watt Steady State

Feature

- * 1 W SOD-123-FL
- * Zener voltage regulator diodes
- * Plastic package has Underwriters Laboratory Flammability Classification 94V-0
- * We declare that the material of product compliance with RoHS requirements.
- * S- prefix for automotive and other applications requiring unique site and control change requirements; AEC-Q101 qualified and PPAP capable.
- * Guarding for over voltage protection
- * High temperature soldering guaranteed:
260°C/10 seconds at terminals
- * MSL: 1

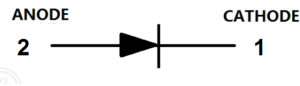
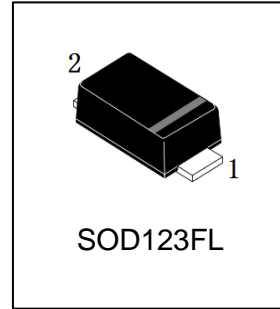

Mechanical Data

Case: JEDEC SOD-123-FL/MINI SMA molded plastic

Terminals :Plated terminals, solderable per MIL-STD-750,Method 2026

Polarity: Color band denoted cathode except Bipolar

Mounting Position: Any

Weight : Approximated 0.0155 gram

1.Electrical Characteristic

Ratings at 25°C ambient temperature unless otherwise specified.

Single phase, half wave, 60Hz, resistive or inductive load.

For capacitive load, derate current by 20%.

RATING	SYMBOL	VALUE	UNITS
Steady State Power Dissipation at $T_c=75^\circ\text{C}$ (Note1)	$P_{M(AV)}$	1.0	Watts
Z-current	I_Z	P_V/V_Z	mA
Operating and Storage Temperature Range	T_J, T_{STG}	-50 to +150	$^\circ\text{C}$

NOTES:

1. 8.0mm² (.013mm thick) land areas
2. 8.3ms single half sine-wave, duty cycle= 4 pulses per minutes maximum.

S-SODZ ***A -SH Series

2.Product Characteristic

Vz tolerance : ±5%; Tested with pulse tp=40ms; Ta=25 °C Vmax =1.2V @ IF = 200mA P=1 W

Type	Device marking code	Zener	Current	A and B Suffix only			Leakage Current		Maximum Regulator Current2)	
		Voltage	Izt	Zzt @ Izt	Zzk @ Izk	Zzk @ Izk	IR	VR	IZM @ Tamb =50 ° C	
		$V_z @ I_{zt}$								
		Volts	mA	Ohms	Ohms	mA	uA Max	Volts	mA	
S-SODZ5.1A-SH	Z5.1	5.1	49	7	550	1	100	1.0	178	
S-SODZ5.6A-SH	Z5.6	5.6	45	5	600			2.0	164	
S-SODZ6.2A-SH	Z6.2	6.2	41	2	700			3.0	146	
S-SODZ6.8A-SH	Z6.8	6.8	37	4	1300			4	133	
S-SODZ7.5A-SH	Z7.5	7.5	34	4.5	1300			0.5	5	121
S-SODZ8.2A-SH	Z8.2	8.2	31	5.5	1300			0.5	6	110
S-SODZ9.1A-SH	Z9.1	9.1	28	6	1300			0.5	7	100
S-SODZ10A-SH	Z10	10	25	7	1300	0.25	5	7.6	91	
S-SODZ11A-SH	Z11	11	23	8	1300			8.4	83	
S-SODZ12A-SH	Z12	12	21	9	1300			9.1	76	
S-SODZ13A-SH	Z13	13	19	10	1300			9.9	69	
S-SODZ15A-SH	Z15	15	17	14	1300			11.4	61	
S-SODZ16A-SH	Z16	16	15.5	16	1300			12.2	57	
S-SODZ18A-SH	Z18	18	14	20	1300			13.7	50	
S-SODZ20A-SH	Z20	20	12.5	22	1300			15.2	45	
S-SODZ22A-SH	Z22	22	11.5	23	1300			16.7	41	
S-SODZ24A-SH	Z24	24	10.5	25	1300			18.2	38	
S-SODZ27A-SH	Z27	27	9.5	35	1300			20.6	34	
S-SODZ30A-SH	Z30	30	8.5	40	1500			22.8	30	
S-SODZ33A-SH	Z33	33	7.5	45	1500			25.1	27	
S-SODZ36A-SH	Z36	36	7	50	1500			27.4	25	
S-SODZ39A-SH	Z39	39	6.5	60	1500			29.7	23	
S-SODZ43A-SH	Z43	43	6	70	2500			32.7	22	
S-SODZ47A-SH	Z47	47	5.5	80	2500			35.8	19	
S-SODZ51A-SH	Z51	51	5	95	2500			38.8	18	
S-SODZ56A-SH	Z56	56	4.5	110	2500			42.6	16	
S-SODZ62A-SH	Z62	62	4	125	2500			47.1	14	
S-SODZ68A-SH	Z68	68	3.7	150	2500	51.7	13			
S-SODZ75A-SH	Z75	75	3.3	175	2500	56	12			
S-SODZ82A-SH	Z82	82	3	200	3000	62.2	11			
S-SODZ91A-SH	Z91	91	2.8	250	3000	69.2	10			
S-SODZ100A-SH	Z100	100	2.5	350	3000	76	9			
S-SODZ110A-SH	Z110	110	2	550	5000	83	8			
S-SODZ120A-SH	Z120	120	1.5	750	5500	90	7			
S-SODZ130A-SH	Z130	130	1	900	6000	98	6			
S-SODZ150A-SH	Z150	150	1	1200	6500	113	6			
S-SODZ160A-SH	Z160	160	1	1350	7000	120	6			
S-SODZ180A-SH	Z180	180	1	1650	8500	135	5			
S-SODZ200A-SH	Z200	200	1	1950	10000	150	4			

S-SODZ ***A -SH Series

3.Characteristic Curves

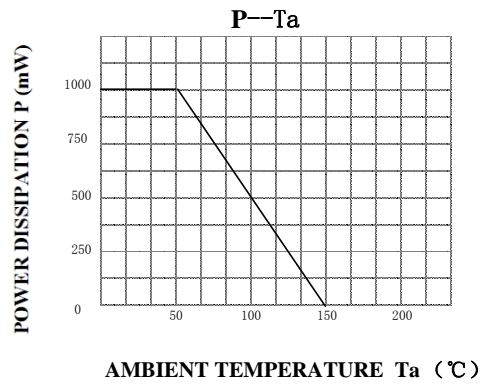
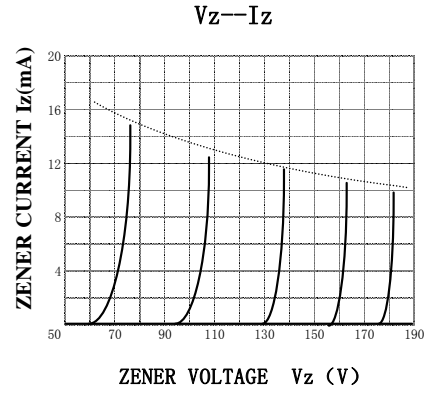
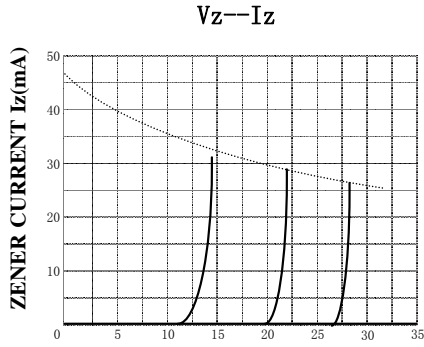

4. OUTLINE AND DIMENSIONS

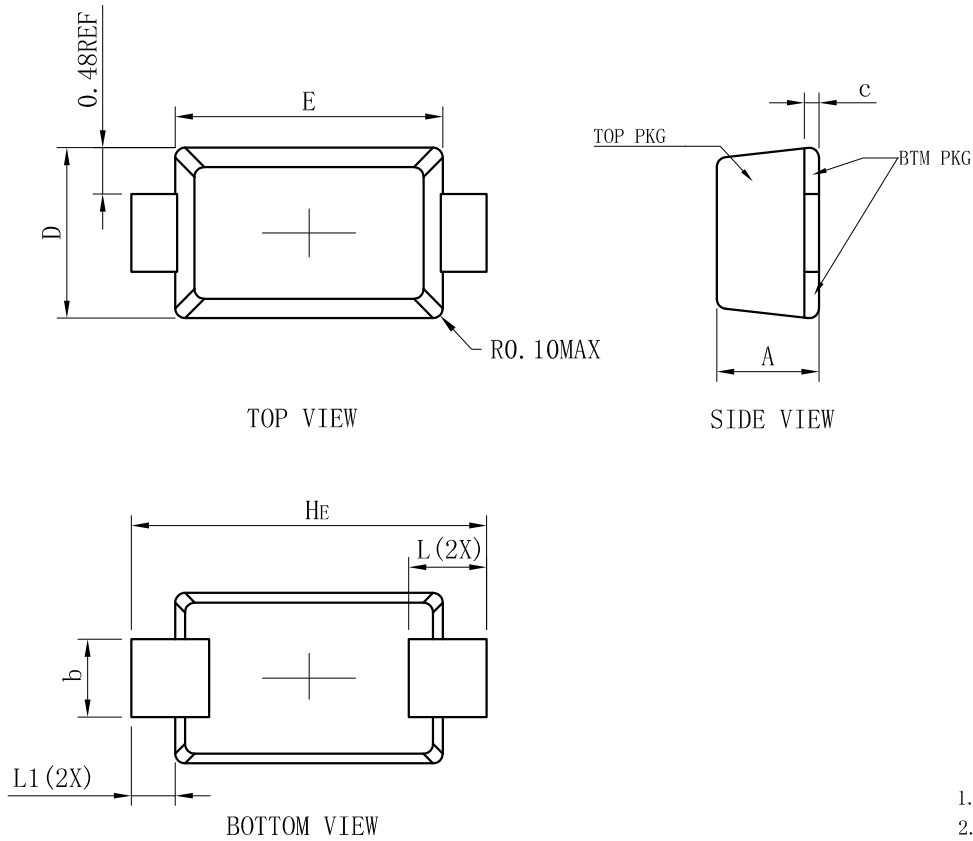

SOD123FL			
DIM	MIN	NOR	MAX
A	0.90	1.05	1.15
b	0.75	0.80	0.95
L	0.80REF.		
E	2.60	2.75	2.90
D	1.60	1.75	1.90
HE	3.50	3.65	3.80
c	0.12	0.17	0.22
L1	0.45REF.		
All Dimensions in mm			

GENERAL NOTES

1. Top package surface finish $Ra0.4\pm0.2\mu m$
2. Bottom package surface finish $Ra0.7\pm0.2\mu m$
3. Side package surface finish $Ra0.4\pm0.2\mu m$

5. SOLDERING FOOTPRINT

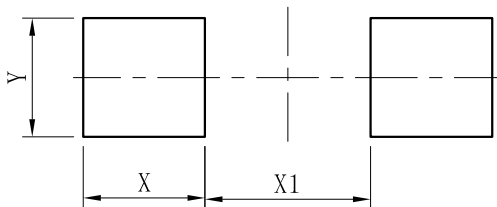

DIM	(mm)
X	1.20
Y	1.10
X1	2.00

S-SODZ ***A -SH Series

6. Suggested thermal profile for soldering process

1. Storage environment : Temperature=5~40°C Humidity=55±25%
2. Reflow soldering of surface-mount device

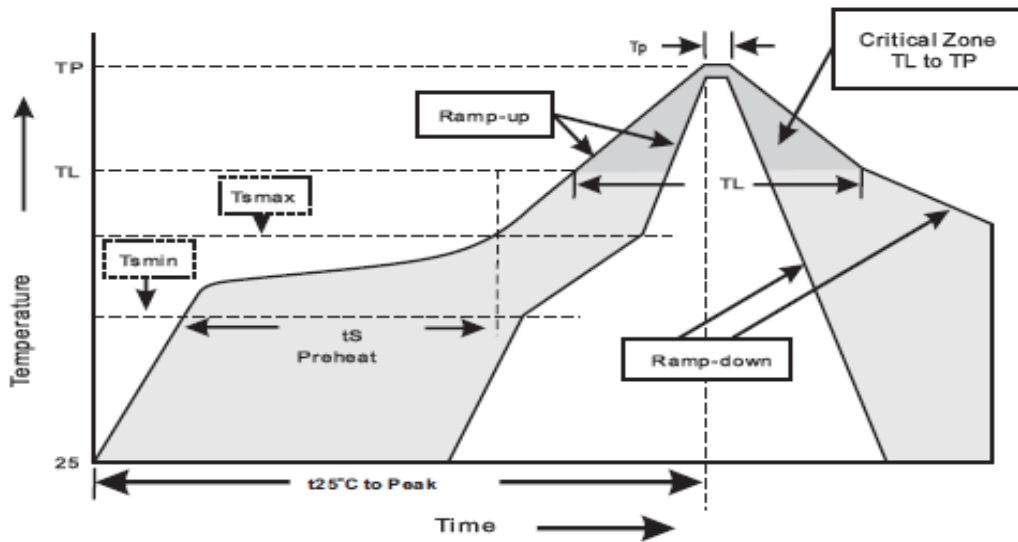

3. Reflow soldering

Profile Feature	Soldering Condition
Average ramp-up rate(T _L to T _P)	<3°C/sec
Preheat	
- Temperature Min(T _{smmin})	150°C
- Temperature Max(T _{smmax})	200°C
- Time(min to max)(t _s)	60~120sec
T _{smmax} to T _L	
- Ramp-up Rate	<3sec
Time maintained above:	
- Temperature (T _L)	217°C
- Time(t _L)	60-260sec
Peak Temperature(T _P)	255 -0/+5°C
Time within 5°C of actual Peak Temperature(T _P)	10~30sec
Ramp-down Rate	<6°C/sec
Time 25°C to Peak Temperature	<6minutes

S-SODZ ***A -SH Series

7.High reliability test capabilities

Item Test	Condition	Reference
Solder Resistance	at 260±5°C for 10±2sec immerse body into solder 1/16" ± 1/32"	MIL-STD-750D METHOD-2031
Solderability	at 245±5°C for 5 sec	MIL-STD-202F METHOD-208
High Temperature Reverse Bias	V _R =80% rate at T _J =150°C for 168hrs	MIL-STD-750D METHOD-1038
Forward Operation Life	Rated average rectifier current T _A =25°C for 500hrs	MIL-STD-750D METHOD-1027
Intermittent Operation Life	T _A =25°C , I _F =I _o On state:power on for 5 min. Off state:power off for 5 min. on and off for 500 cycles	MIL-STD-750D METHOD-1036
Pressure Cooker	15P _{SIG} at T _A =121°C for 4hrs	JESD22-A102
Temperature Cycling	-55°C to +125°C dwelled for 30 min. and transferred for 5min. Total 10 cycles	MIL-STD-750D METHOD-1051
Thermal Shock	0°C for 5min. Rise to 100°C for 5min. Total 10 cycles	MIL-STD-750D METHOD-1056
Forward Surge	8.3ms single half sine-wave superimposed on rated load,one surge	MIL-STD-750D METHOD-4066-2
Humidity	at T _A =85°C , RH=85% for 1000hrs	MIL-STD-750D METHOD-1021
High Temperature Storage Life	at 175°C for 1000hrs	MIL-STD-750D METHOD-1031



Proprietary Information

Title: Power Packages Product Packing Specification

功率产品包装规范

Document Number: APS-QA-QS-009

Revision C

Page 3 of 6



8.1.2 Label position and QA stamp position.(Empty area) 标签张贴位置及QA印章位置。(印章盖在标签空白区)



7英寸卷盘标签张贴及QA印章位置



13英寸卷盘标签张贴及QA印章位置

8.1.3 Ensure direction In the same reel. The same steel coil plate direction, With antistatic bubble to package reel. Refer to the below picture.
同一箱内的卷盘方向一致,用防静电泡沫对卷盘进行包裹。

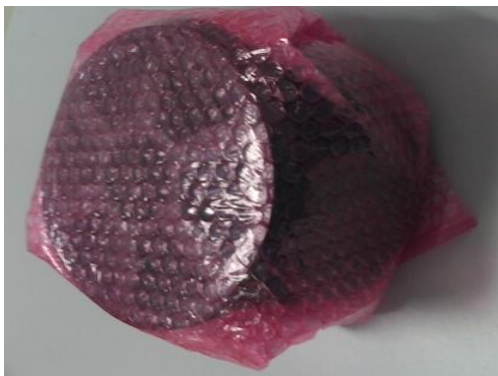

7英寸卷盘防静电泡沫包裹



13英寸卷盘防静电泡沫包裹

Do not copy without written permission from Advanced Power Semiconductor



Proprietary Information

Title: Power Packages Product Packing Specification

功率产品包装规范

Document Number: APS-QA-QS-009

Revision C

Page 4 of 6

8.1.4 Put in the antistatic packing box after packaged reels. And QA stamp on the box label .

将包装好的卷盘放入防静电纸箱中，并在盒标签上盖章。



7 英寸卷盘内盒及标签



13 英寸卷盘内盒及标签

8.1.5 Product use printing inner box. 产品使用LRC印字内箱。



7英寸卷盘内箱印字（侧面）



13英寸卷盘内箱印字（正面）

8.1.6 Inner box packing quantity requirement. 内盒包装数量要求。

Product Description	QTY
SOD123-FL	1-10Reels
SOD323-HE	1-10Reels
SMA-FL	1-7Reels
SMB-FL	1-4Reels

8.1.7 With transparent tape sealing. 透明胶带封箱。



Proprietary Information

Title: Power Packages Product Packing Specification

功率产品包装规范

Document Number: APS-QA-QS-009

Revision C

Page 5 of 6



7英寸内箱封盒



13英寸内箱封盒

8.1.8 Outer box size and packing quantity requirement, 外箱尺寸及包装数量要求。

Product Description	卷盘尺寸	Height (H)	Width (W)	Length (L)	Max. Qty
Power Device	7 英寸	410mm	400mm	445mm	12
Power Device	13 英寸	410mm	400mm	445mm	5



7 英寸卷盘产品装箱



13 英寸卷盘产品装箱

统一方向



Proprietary Information

Title: Power Packages Marking & Taping Specification

功率封装字模和编带规范

Document Number: APS-QA-QS-010

Revision C

Page 6 of 9

8.2 Standard Products Taping Specification

标准产品编带规范

8.2.1 Tape length of no component

空带长度说明

Taping leader length 引导部分: 440mm±40mm , Tape trailer 尾部: 200mm±40mm

Figure 4

Tape Ends For Finished Goods Reel



8.2.2 Component packaging orientation: The cathode lead is close to the carrier tape's index hole.

产品放置方向: 印阴极带引脚邻近载带索引孔





Proprietary Information

Title: Power Packages Marking & Taping Specification

功率封装字模和编带规范

Document Number: APS-QA-QS-010

Revision C

Page 7 of 9

8.2.3 Tape enwind orientation

编带缠绕方向要求

