

# HSF

NOTES:  
 Current Rating: 3.0AMP  
 Contact Resistance: 20mΩ Max  
 Withstand Voltage: 500V AC/DC  
 Insulation Resistance: 1000MΩ Min  
 Operation Temperature: -55°C to +105°C

Contact Material: Phosphor Bronze/Brass  
 Contact plating: Au Or Sn over Ni  
 Insulator Material: PBT+30%G.F UL94V-0  
 Sheel: Cold Roller Steel, Ni Or Sn Plated  
 Nut: Brass, Sn Over Ni Plated

## Ordering Information

6222-XXMXXXB01

No. of Pins:	Type:	Contact Plating:	Insulator Color:
9P	Y: With Back Fork	S0=Gold Flash/Tin	W= White
15P	B: With Back Nut	S3=10u"Gold/Tin	B= Black
25P	F: With Front Nut	S4=15u"Gold/Tin	U= Blue
37P	H: With Front Nut With Back Fork	S5=30u"Gold/Tin	
	N: Without Fork Without Nut	SN=Tin	

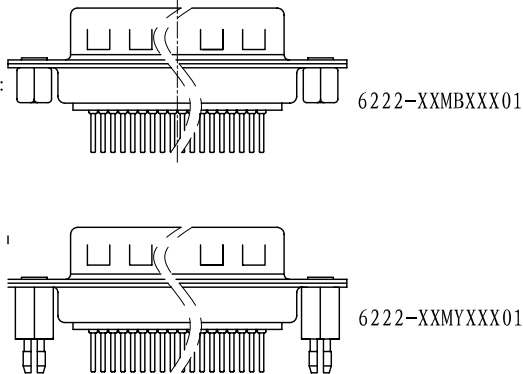
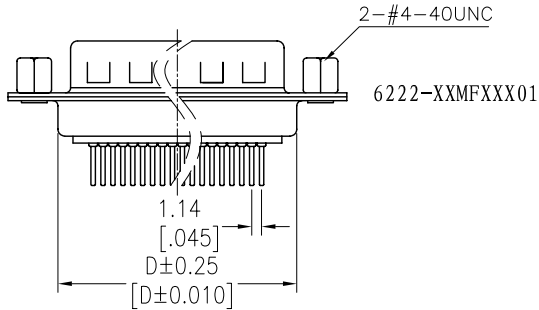
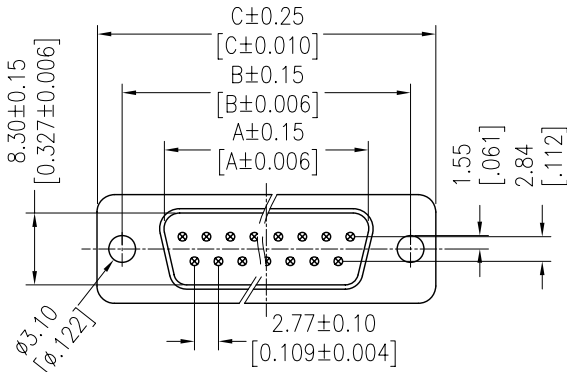

Recommended P.C.B Layout (Top Side)  
 (PCB BOARD TOLERANCE ±0.05)

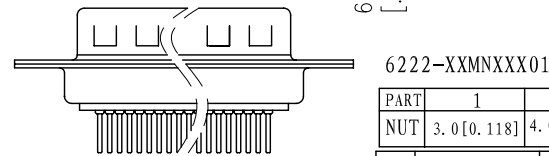
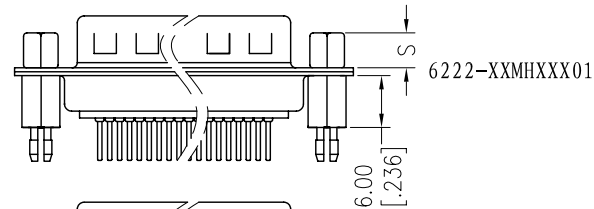
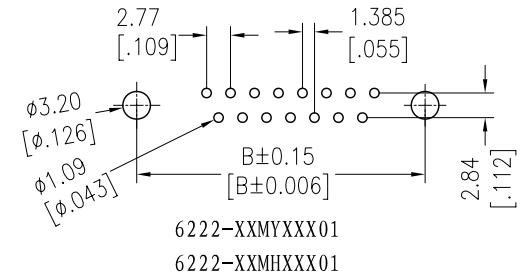
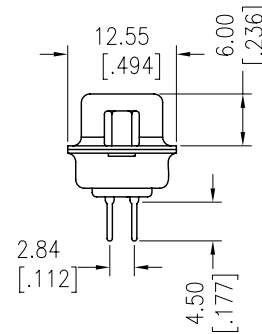
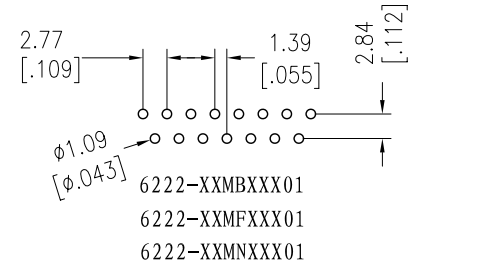

PART	1	2	3	4	5
NUT	3.0 [0.118]	4.0 [0.158]	6.0 [0.236]	6.5 [0.256]	4.8 [0.189]
PIN	DIM "A"	DIM "B"	DIM "C"	DIM "D"	
09	16.92 [0.666]	24.99 [0.984]	30.81 [1.213]	19.28 [0.759]	
15	25.25 [0.994]	33.32 [1.312]	39.14 [1.541]	27.70 [1.091]	
25	38.96 [1.534]	47.04 [1.852]	53.10 [2.091]	41.10 [1.618]	
37	55.42 [2.182]	63.50 [2.500]	69.32 [2.729]	57.30 [2.256]	

				OPERATION	DRAW	DATE	SCALE	FIT	PART NO.	
				x.x ±0.40	JYHuang	2012/12/05	UNIT	mm	6222-XXMXXX01	
				x.xx ±0.25	CHECK	DATE	SIZE	A4	TITLE:	
				x.xxx ±0.15	APPROVE	DATE	SHEET	1/1	D-SUB MALE DUAL ROW 180° DIP	
AO	2012/12/05	NEW	-----	Angle ± 3'			PROJ.	☉	Customer NO.	
REV	DATE	MODIFICATION DESCRIPTION	CHANGE	DIM	TOL					